















EXACT and SEC-EXACT

Accessories and dimensions

Accessories		Order number	Quantity
Protective rubber sleeve for all 1/4" quick change chucks prevents mutilation of work piece		3 605 500 172	5
Snap-in color rings for quick torque range identification fits all C-EXACT straight screwdrivers and all T-grip EXACT cordless drivers	 black	3 600 106 010	5
	 red	3 600 106 011	5
	 light blue	3 600 106 012	5
	 light green	3 600 106 013	5
	 orange	3 600 106 014	5
	 grey	3 600 106 017	5
	 white	3 600 106 019	5
	 mixed	3 600 106 015	5
T-grip bench mount tool holder (for all T-grip tools only)		0 602 490 001	10
Protective cover Prevents damage to work piece; Fits all T-grip EXACT cordless drivers will not block motor air vents sold as a 10-pack only	 transparent	0 602 490 011	10
	 red	0 602 490 012	10
	 blue	0 602 490 013	10
	 green	0 602 490 014	10

All EXACT, BT-EXACT and SEC-EXACT 9.6 volt models
Dimensions in mm

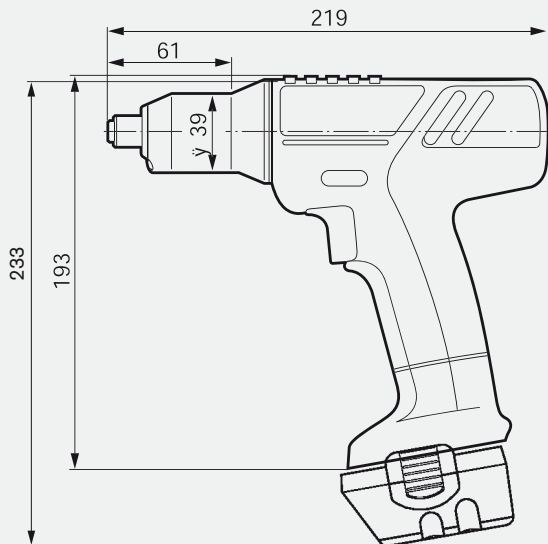

All standard and BT-EXACT 12 volt models
Dimensions in mm

