

Rexroth Tightening System 350

Easy Automation. Efficient Production.





Tightening spindles 0.6–1000 Nm	4
Tightening spindles size 2	8
Tightening spindles size 3	24
Tightening spindles size 4	44
Tightening spindles size 5	64
Accessories for tightening spindles	72
ErgoSpin hand-held nutrunners	74
Accessories for ErgoSpin/CC-ErgoSpin hand-held nutrunners	86
Nexo – intelligent cordless nutrunners	90
Accessories and extensions	93
Control and power electronics	96
Interface modules	118
Cables	122
Software and operating system	130
Customized solutions	136
Rating of a tightening connection	138
Clamping force table	139
Glossary	140

Tightening spindles 0.6 – 1000 Nm

The modular construction of Rexroth tightening spindles enables a very precise adjustment to the tightening task at hand. Conformity with the VDI standard ensures that your tightening connections meet the highest safety requirements. The versatility of Rexroth tightening spindles not only guarantees safety but also a perfect design customized to your needs.



- ▶ Modular design, ideal adjustment to tightening case
- ▶ Maintenance-free for 1 million full-load cycles, long service life
- ▶ Process reliability and minimal waste thanks to real redundancy measurement
- ▶ Digital measurement transfer, maximum precision

Maximum flexibility in tightening spindle configuration – here are just some of the many options



Tightening spindle with angle head

- ▶ For high accessibility
- ▶ Also available with integrated measurement transducer



Tightening spindle with offset output drive

- ▶ For side-by-side arrangement with small center-to-center distances
- ▶ Also available with integrated measurement transducer

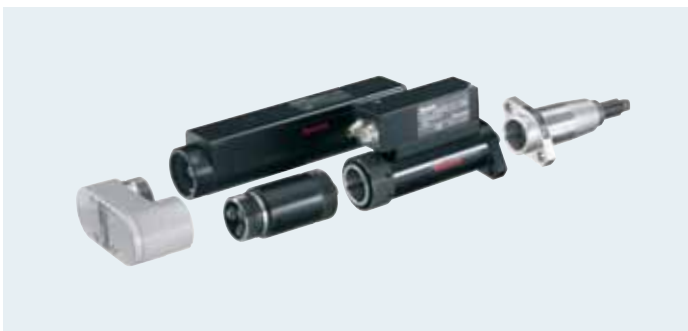

Tightening spindle with transverse gearbox

- ▶ Compact length
- ▶ Available for all sizes



Tightening spindle with feed output drive

- ▶ Integrated feed movement
- ▶ For use in connection with automatic bolt supply

Configure your tightening spindle

Numerous options

With a working range between 0.6 and 1000 Nm (higher torques on request) and a choice between straight output drives, offset output drives, feed output drives, and angle heads – with Rexroth components you can configure a tightening spindle that is customized to your individual requirements. We offer the offset output drive and angle head also with integrated measurement transducer. You can decide between having one measurement transducer or a second redundant one. We can provide the optimum spindle components for any task. Why not find the perfect tightening spindle for your tightening connection?

Depending on the size, the actual components may differ from those in the illustration.

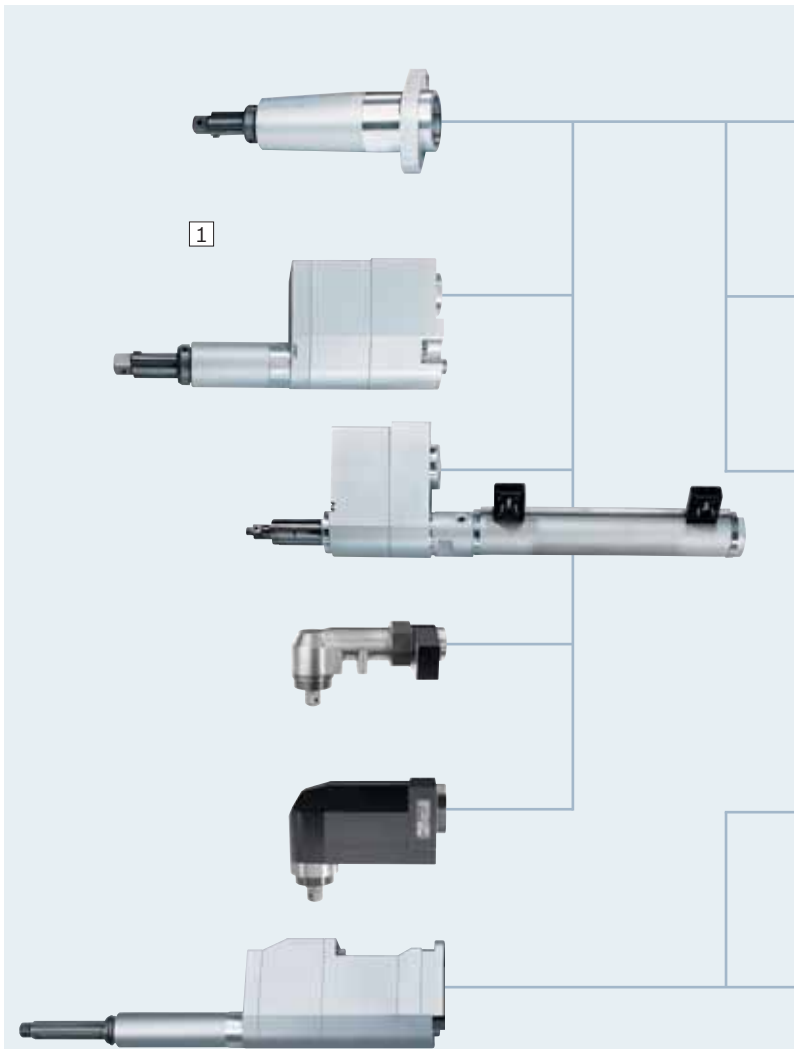

1 Output drives

- The suitable output drive for every tightening position
- Special output drives for increased transverse forces, e.g. for wheel nutrunners, on request

2 Adapter A

- Connects planetary gearbox and output drive when operating without a measurement transducer

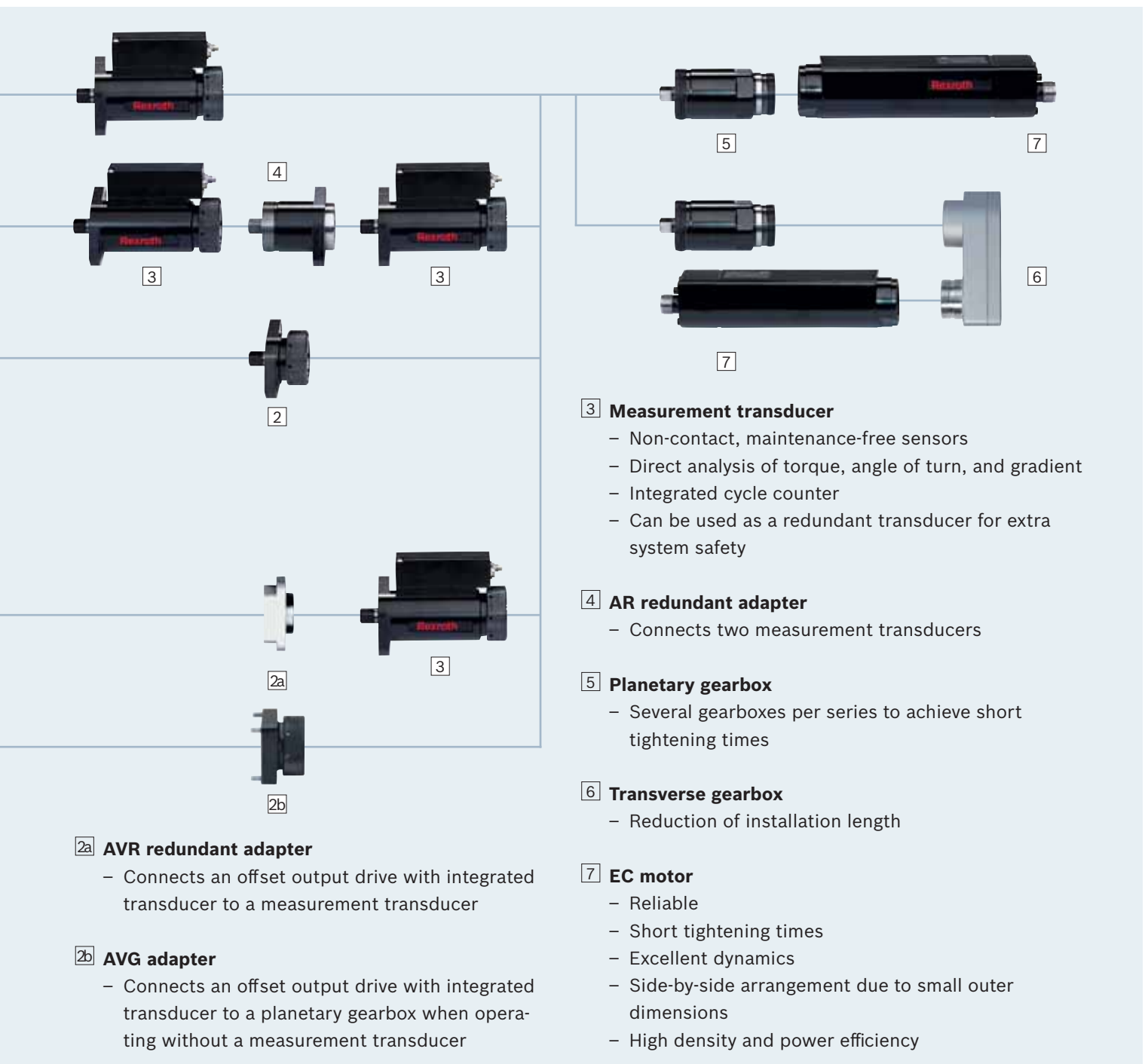

Tightening spindles size 2 Spindle bearing



- ▶ Working range 0.6–10 Nm
- ▶ Max. output drive speed 1000 rpm

Depending on the size, the actual components may differ from those in the illustration.

Features

- ▶ Various lengths with axial compensator
- ▶ Standard tool mounts
- ▶ Maximum efficiency
- ▶ Easy assembly due to flange connection
- ▶ Maintenance-free for 1 million full-load cycles

Tightening spindle		Spindle bearing				Measurement transducer	Planetary gearbox	EC motor
Working range *	Max. output drive speed	Range of spring mm/ Max. spring force N	Tool mount	Code	Order no.	Code/ Order no.	Code/ Order no.	Code/ Order no.
Nm	rpm							
0.6–5.5	1000	20/ 34.1	1/4" square	2GA82	0 608 800 077	2DMC006 0608 820 110	2GE19 0608 720 043	EC302 0608 701 016
	1000	20/ 34.1	1/4" quick-change chuck	2GB82	0 608 800 078			
	1000	20/ 34.1	1/4" quick-change chuck	2GB82F73	0 608 800 085			
	780	20/ 34.1	1/4" square	2GA82	0 608 800 077	2DMC006 0608 820 110	2GE26 0608 720 038	
	780	20/ 34.1	1/4" quick-change chuck	2GB82	0 608 800 078			
	780	20/ 34.1	1/4" quick-change chuck	2GB82F73	0 608 800 085			
1.2–10	1000	20/ 34.1	1/4" square	2GA82	0 608 800 077	2DMC012 0608 820 111	2GE19 0608 720 043	EC302 0608 701 016
	1000	20/ 34.1	1/4" quick-change chuck	2GB82	0 608 800 078			
	1000	20/ 34.1	1/4" quick-change chuck	2GB82F73	0 608 800 085			
	780	20/ 34.1	1/4" square	2GA82	0 608 800 077	2DMC012 0608 820 111	2GE26 0608 720 038	
	780	20/ 34.1	1/4" quick-change chuck	2GB82	0 608 800 078			
	780	20/ 34.1	1/4" quick-change chuck	2GB82F73	0 608 800 085			





* Accuracy is limited if operating below the working range.

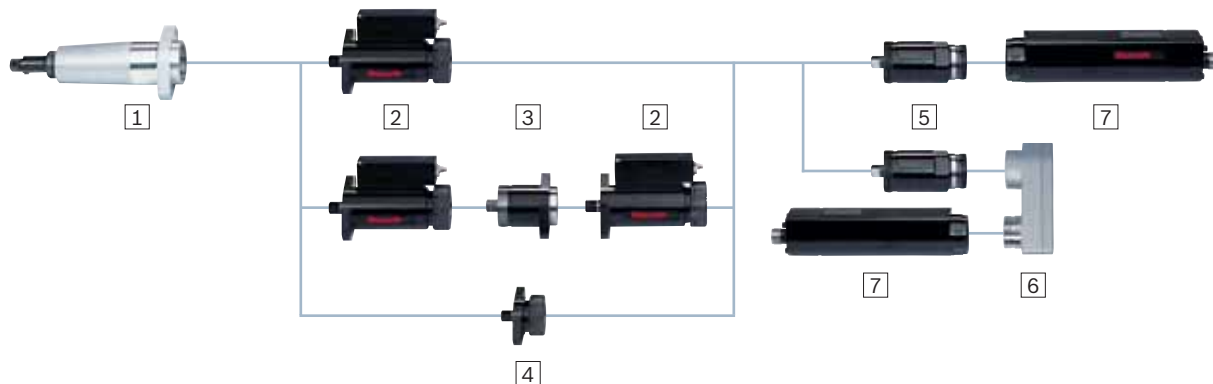

Note: You can find component dimensions and 3D/CAD data on the Internet at www.boschrexroth.com/tightening





Spindle bearing size 2

Components



1 Spindle bearing 	Code		2GA82	2GB82	
	Order no.		0608800077	0608800078	
	Max. torque	Nm	10	10	
	Range of spring	mm	20	20	
	Reduction		1	1	
	Avg. efficiency		1	1	
	Length A	mm	82	82	
	Installation length	mm	90	90	
	Weight	kg	0.2	0.2	
2 Measurement transducer 	Code		2DMC006	2DMC012	
	Order no.		0608820110	0608820111	You can configure your tightening spindle with a redundant measurement transducer from the same type. Connect both measurement transducers with the adapter. For measurement transducer cables, see page 126.
	Nominal torque	Nm	6	12	
	Reduction		1	1	
	Avg. efficiency		1	1	
	Installation length	mm	118.5	118.5	
Weight	kg	0.55	0.55		
3 Redundant adapter 	Code		2AR		When configuring with a redundant measurement transducer, the adapter connects both measurement transducers.
	Order no.		0608810020		
	Reduction		1		
	Avg. efficiency		1		
	Installation length	mm	50		
Weight	kg	0.3			
4 Adapter 	Code		2A		When configuring without a measurement transducer, the adapter connects the output drive and the planetary gearbox.
	Order no.		0608810024		
	Reduction		1		
	Avg. efficiency		1		
	Installation length	mm	30		
Weight	kg	0.4			

5 Planetary gearbox 	Code	2GE19	2GE26	
	Order no.	0 608 720 043	0 608 720 038	
	Reduction	18.9	25.5	
	Avg. efficiency	0.93	0.9	
	Installation length	mm	50.9	50.9
	Weight	kg	0.4	0.4
6 Transverse gearbox 	Code	2ULG		
	Order no.	0 608 PE0 282	The transverse gearbox shortens the length of your tightening spindle by the installation length of the EC motor plus the installation length of the transverse gearbox.	
	Reduction	1	The use of a transverse gearbox decreases the tightening spindle working area.	
	Avg. efficiency	0.95		
	Installation length	mm	28.3	
	Weight	kg	0.4	
7 EC motor 	Code	EC302		
	Order no.	0 608 701 016		
	Installation length	mm	197	
	Weight	kg	0.72	

Side-by-side arrangement of tightening spindles (center-to-center distance)						
Number of tightening spindles	2	3	4	5	6	
						
Min. circle diameter- $\varnothing d_{\min}$ mm	2VNA82	35	40	55	64	74

Tightening spindles size 2 Offset output drive



- ▶ Working range 0.6–10 Nm
- ▶ Max. output drive speed 1000 rpm

Depending on the size, the actual components may differ from those in the illustration.

Features

- ▶ For tight hole templates, side-by-side arrangement with small center-to-center distances
- ▶ Standard tool mounts
- ▶ Easy assembly due to flange connection
- ▶ Maintenance-free for 1 million full-load cycles

Tightening spindle		Offset output drive				Measurement transducer	Planetary gearbox	EC motor
Working range *	Max. output drive speed	Range of spring	Tool mount	Code	Order no.	Code/Order no.	Code/Order no.	Code/Order no.
Nm	rpm	mm						
0.6–5	1000	20	1/4" square	2VNA82	0608800607	2DMC006 0608820110	2GE19 0608720043	EC302 0608701016
	1000	20	1/4" quick-change chuck	2VNB82	0608800608			
	780	20	1/4" square	2VNA82	0608800607		2GE26 0608720038	
	780	20	1/4" quick-change chuck	2VNB82	0608800608			
1.2–10	1000	20	1/4" square	2VNA82	0608800607	2DMC012 0608820111	2GE19 0608720043	EC302 0608701016
	1000	20	1/4" quick-change chuck	2VNB82	0608800608			
	780	20	1/4" square	2VNA82	0608800607		2GE26 0608720038	
	780	20	1/4" quick-change chuck	2VNB82	0608800608			





* Accuracy is limited if operating below the working range.

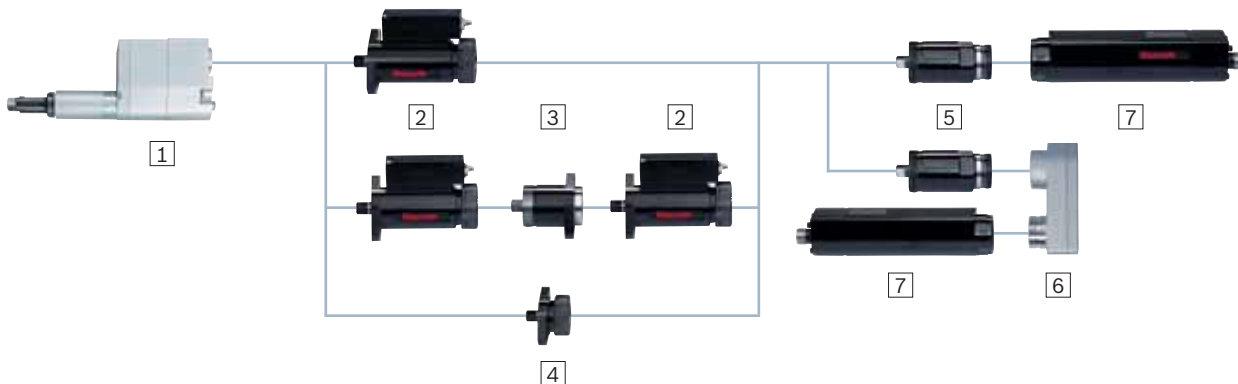

Note: You can find component dimensions and 3D/CAD data on the Internet at www.boschrexroth.com/tightening





Offset output drive size 2

Components



1 Offset output drive 	Code		2VNA82	2VNB82	
	Order no.		0 608 800 607	0 608 800 608	
	Max. torque	Nm	10	10	
	Range of spring	mm	20	20	
	Reduction		1	1	
	Avg. efficiency		0.9	0.9	
	Length A	mm	82	82	
	Installation length	mm	153	153	
	Weight	kg	0.6	0.6	
2 Measurement transducer 	Code		2DMC006	2DMC012	
	Order no.		0 608 820 110	0 608 820 111	You can configure your tightening spindle with a redundant measurement transducer from the same type. Connect both measurement transducers with the redundant adapter. For measurement transducer cables, see page 126.
	Nominal torque	Nm	6	12	
	Reduction		1	1	
	Avg. efficiency		1	1	
	Installation length	mm	118.5	118.5	
Weight	kg	0.55	0.55		
3 Redundant adapter 	Code		2AR		When configuring with a redundant measurement transducer, the adapter connects both measurement transducers.
	Order no.		0 608 810 020		
	Reduction		1		
	Avg. efficiency		1		
	Installation length	mm	50		
Weight	kg	0.3			
4 Adapter 	Code		2A		When configuring without a measurement transducer, the adapter connects the output drive and the planetary gearbox.
	Order no.		0 608 810 024		
	Reduction		1		
	Avg. efficiency		1		
	Installation length	mm	30		
Weight	kg	0.4			

5 Planetary gearbox 	Code	2GE19	2GE26	
	Order no.	0 608 720 043	0 608 720 038	
	Reduction	18.9	25.5	
	Avg. efficiency	0.93	0.9	
	Installation length	mm	50.9	50.9
	Weight	kg	0.4	0.4
6 Transverse gearbox 	Code	2ULG		
	Order no.	0 608 810 054	The transverse gearbox shortens the length of your tightening spindle by the installation length of the EC motor plus the installation length of the transverse gearbox. The use of a transverse gearbox decreases the tightening spindle working area.	
	Reduction	1		
	Avg. efficiency	0.95		
	Installation length	mm		28.3
	Weight	kg		0.4
7 EC motor 	Code	EC302		
	Order no.	0 608 701 016		
	Installation length	mm	197	
	Weight	kg	0.72	

Side-by-side arrangement of tightening spindles (center-to-center distance)						
Number of tightening spindles		2	3	4	5	6
						
Min. circle diameter- $\varnothing d_{\min}$ mm	2VN...82	23	27	33	41	52

Tightening spindles size 2 Angle head



- ▶ Working range 0.6–11 Nm
- ▶ Max. output drive speed 1000 rpm

Depending on the size, the actual components may differ from those in the illustration.

Features

- ▶ For restricted accessibility
- ▶ Precision tothing for high torque accuracy
- ▶ Incremental positioning
- ▶ Integrated fastening flanges
- ▶ With integrated measurement transducer on request

Tightening spindle		Angle head			Measurement transducer	Planetary gearbox	EC motor
Working range *	Max. output drive speed	Tool mount	Code	Order no.	Code/ Order no.	Code/ Order no.	Code/ Order no.
Nm	rpm						
0.6–5.5	1000	1/4" square	2W11	0608810041	2DMC006 0608820110	2GE19 0608720043	EC302 0608701016
	740	1/4" square	2W11	0608810041	2DMC006 0608820110	2GE26 0608720038	
1.2–11	1000	1/4" square	2W11	0608810041	2DMC012 0608820111	2GE19 0608720043	EC302 0608701016
	740	1/4" square	2W11	0608810041	2DMC012 0608820111	2GE26 0608720038	

* Accuracy is limited if operating below the working range.

Note: You can find component dimensions and 3D/CAD data on the Internet at www.boschrexroth.com/tightening

Angle head with spindle bearing

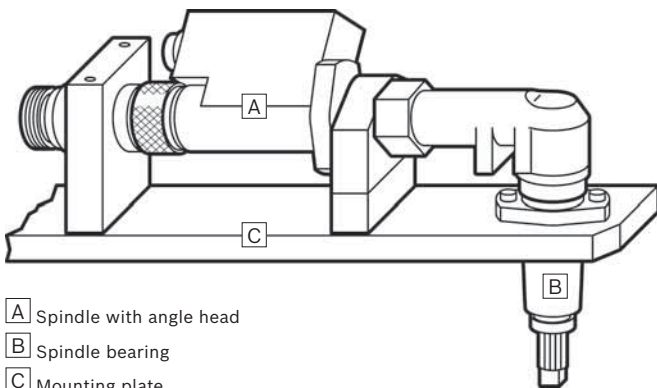

- A** Spindle with angle head
- B** Spindle bearing
- C** Mounting plate

Axial compensator





To ensure troublefree operation, the angle head must always be operated with an output drive axial compensator, e.g. spindle bearing.

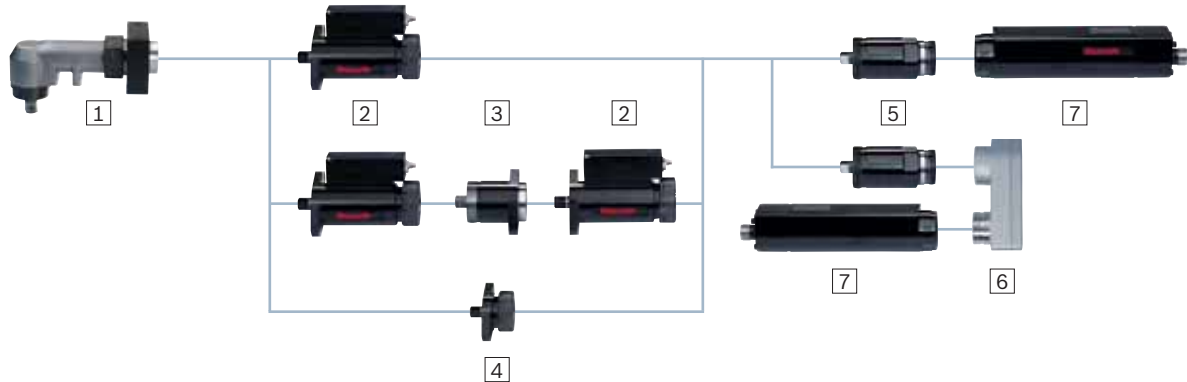

You can find more information in the planning instructions for angle heads in the Rexroth media directory at www.boschrexroth.com/mediadirectory





Angle head size 2

Components



1 Angle head 	Code	2W011			
	Order no.	0608810041			
	Max. torque	Nm	11		
	Reduction		1.05		
	Avg. efficiency		0.95		
	Installation length	mm	81.5		
	Weight	kg	0.7		
2 Measurement transducer 	Code	2DMC006	2DMC012		
	Order no.	0608820110	0608820111	You can configure your tightening spindle with a redundant measurement transducer from the same type. Connect both measurement transducers with the adapter. For measurement transducer cables, see page 126.	
	Nominal torque	6	12		
	Reduction	1	1		
	Avg. efficiency	1	1		
	Installation length	mm	118.5		118.5
	Weight	kg	0.55		0.55
3 Redundant adapter 	Code	2AR			
	Order no.	0608810020		When configuring with a redundant measurement transducer, the adapter connects both measurement transducers.	
	Reduction	1			
	Avg. efficiency	1			
	Installation length	mm	50		
	Weight	kg	0.3		
4 Adapter 	Code	2A			
	Order no.	0608810024		When configuring without a measurement transducer, the adapter connects the output drive and the planetary gearbox.	
	Reduction	1			
	Avg. efficiency	1			
	Installation length	mm	30		
	Weight	kg	0.4		

5 Planetary gearbox	Code	2GE19	2GE26
	Order no.	0608720043	0608720038
	Reduction	18.9	25.5
	Avg. efficiency	0.93	0.9
	Installation length	mm 50.9	50.9
	Weight	kg 0.4	0.4
6 Transverse gearbox	Code	2ULG	
	Order no.	0608810054	The transverse gearbox shortens the length of your tightening spindle by the installation length of the EC motor plus the installation length of the transverse gearbox. The use of a transverse gearbox decreases the tightening spindle working area.
	Reduction	1	
	Avg. efficiency	0.95	
	Installation length	mm 28.3	
	Weight	kg 0.4	
7 EC motor	Code	EC302	
	Order no.	0608701016	
	Installation length	mm 197	
	Weight	kg 0.72	

Side-by-side arrangement of tightening spindles (center-to-center distance)					
Number of tightening spindles	2	3	4	5	6
					
Min. circle diameter- $\varnothing d_{\min}$ mm	2W011 26	30	36	44	52

Tightening spindles size 2 Feed output drive



- ▶ Working range 0.6–10 Nm
- ▶ Max. output drive speed 1000 rpm

Depending on the size, the actual components may differ from those in the illustration.

Features





- ▶ Integrated feed movement
- ▶ In connection with automatic bolt supply
- ▶ Standard tool mounts and compressed air connections
- ▶ Easy assembly due to flange connection
- ▶ Maintenance-free for 1 million full-load cycles

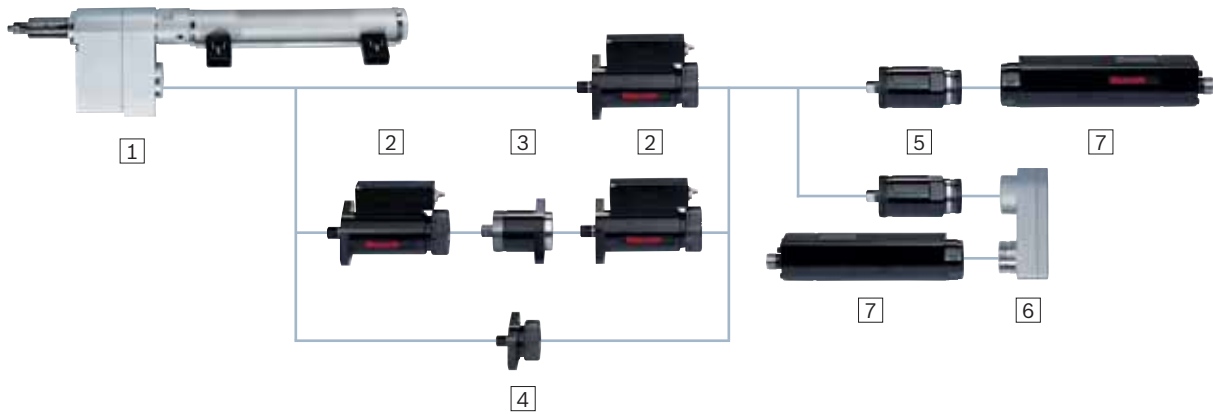

Tightening spindle		Feed output drive				Measurement transducer	Planetary gearbox	EC motor
Working range *	Max. output drive speed Nm rpm	Stroke mm	Tool mount	Code	Order no.	Code/ Order no.	Code/ Order no.	Code/ Order no.
0.6–5.5	1000	160	1/4" square	2S1	0608800612	2DMC006	2GE19	EC302
			M6 outer thread	2S2	0608800619	0608820110	0608720043	0608701016
	780	160	1/4" square	2S1	0608800612	2DMC006	2GE26	
			M6 outer thread	2S2	0608800619	0608820110	0608720038	
1.2–7	1000	160	M6 outer thread	2S2	0608800619	2DMC012 0608820111	2GE19 0608720043	EC302 0608701016
	780	160	M6 outer thread	2S2	0608800619	2DMC012 0608820111	2GE26 0608720038	
1.2–10	1000	160	1/4" square	2S1	0608800612	2DMC012 0608820111	2GE19 0608720043	EC302 0608701016
	780	160	1/4" square	2S1	0608800612	2DMC012 0608820111	2GE26 0608720038	

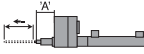
* Accuracy is limited if operating below the working range.





Note: You can find component dimensions and 3D/CAD data on the Internet at www.boschrexroth.com/tightening

Feed output drive size 2
Components

1 Feed output drive	Code	2S1	2S2	
	Order no.	0 608 800 612	0 608 800 619	
	Max. torque	Nm 10	7	
	Stroke	mm 160	160	
	Max. air pressure	bar 4	4	
	Reduction	1	1	
	Avg. efficiency	0.93	0.93	
	Length A	mm 80	80	
	Installation length	mm 189.5	189.5	
	Weight	kg 2	2	
	Tool mount	1/4" square	M6 outer thread	
2 Measurement transducer	Code	2DMC006	2DMC012	
	Order no.	0 608 820 110	0 608 820 111	You can configure your tightening spindle with a redundant measurement transducer with a redundant measurement transducer from the same type. Connect both measurement transducers with the adapter. For measurement transducer cables, see page 126.
	Nominal torque	Nm 6	12	
	Reduction	1	1	
	Avg. efficiency	1	1	
	Installation length	mm 118.5	118.5	
	Weight	kg 0.55	0.55	
3 Redundant adapter	Code	2AR		
	Order no.	0 608 810 020		When configuring with a redundant measurement transducer, the adapter connects both measurement transducers.
	Reduction	1		
	Avg. efficiency	1		
	Installation length	mm 50		
	Weight	kg 0.3		
4 Adapter	Code	2A		
	Order no.	0 608 810 024		When configuring without a measurement transducer, the adapter connects the output drive and the planetary gearbox.
	Reduction	1		
	Avg. efficiency	1		
	Installation length	mm 30		
	Weight	kg 0.4		

5 Planetary gearbox 	Code	2GE19	2GE26	
	Order no.	0608720043	0608720038	
	Reduction	18.9	25.5	
	Avg. efficiency	0.93	0.9	
	Installation length	mm	50.9	50.9
	Weight	kg	0.4	0.4
6 Transverse gearbox 	Code	2ULG		
	Order no.	0608810054	The transverse gearbox shortens the length of your tightening spindle by the installation length of the EC motor plus the installation length of the transverse gearbox. The use of a transverse gearbox decreases the tightening spindle working area.	
	Reduction	1		
	Avg. efficiency	0.95		
	Installation length	mm		28.3
	Weight	kg		0.4
7 EC motor 	Code	EC302		
	Order no.	0608701016		
	Installation length	mm	197	
	Weight	kg	0.72	

Side-by-side arrangement of tightening spindles (center-to-center distance)

Number of tightening spindles	2	3	4	5	6	
						
Min. circle diameter- $\varnothing d_{min}$ mm	2S...	33	38	46	55	65

Tightening spindles size 3 Spindle bearing



- ▶ Working range 1.7 – 55 Nm
- ▶ Max. output drive speed 740 rpm

Depending on the size, the actual components may differ from those in the illustration.

Features

- ▶ Various lengths with axial compensator
- ▶ Standard tool mounts
- ▶ Maximum efficiency
- ▶ Easy assembly due to flange connection
- ▶ Maintenance-free for 1 million full-load cycles

Tightening spindle		Spindle bearing				Measurement transducer	Planetary gearbox	EC motor	
Working range *	Max. output drive speed	Range of spring mm/ Max. spring force N	Tool mount	Code	Order no.	Code/ Order no.	Code/ Order no.	Code/ Order no.	
Nm	rpm								
1.7–16	740	25/ 39	3/8" square	G1A102	0608800062	3DMC017 0608820112	3GE27 0608720053	EC303 0608701017	
			1/4" quick-change chuck	G1B102	0608800063				
			3/8" square with centering pin	G1C102	0608800072				
		50/ 38	3/8" square	G2A152	0608800064				
			1/4" quick-change chuck	G2B152	0608800065				
			3/8" square with centering pin	G2C152	0608800073				
	295	25/ 39	3/8" square	G1A102	0608800062	3DMC017 0608820112	3GE67 0608720039		
			1/4" quick-change chuck	G1B102	0608800063				
			3/8" square with centering pin	G1C102	0608800072				
50/ 38		3/8" square	G2A152	0608800064					
		1/4" quick-change chuck	G2B152	0608800065					
		3/8" square with centering pin	G2C152	0608800073					
6–32	740	25/ 39	3/8" square	G1A102	0608800062	3DMC060 0608820113	3GE27 0608720053	EC303 0608701017	
			1/4" quick-change chuck	G1B102	0608800063				
			3/8" square with centering pin	G1C102	0608800072				
		50/ 38	3/8" square	G2A152	0608800064				
			1/4" quick-change chuck	G2B152	0608800065				
			3/8" square with centering pin	G2C152	0608800073				
	6–35	295	25/ 39	1/4" quick-change chuck	G1B102	0608800063	3DMC060 0608820113	3GE67 0608720039	EC303 0608701017
				50/ 38	1/4" quick-change chuck	G2B152			
	6–55	295	25/ 39	3/8" square	G1A102	0608800062	3DMC060 0608820113	3GE67 0608720039	EC303 0608701017
3/8" square with centering pin				G1C102	0608800072				
50/ 38			3/8" square	G2A152	0608800064				
			3/8" square with centering pin	G2C152	0608800073				





* Accuracy is limited if operating below the working range.

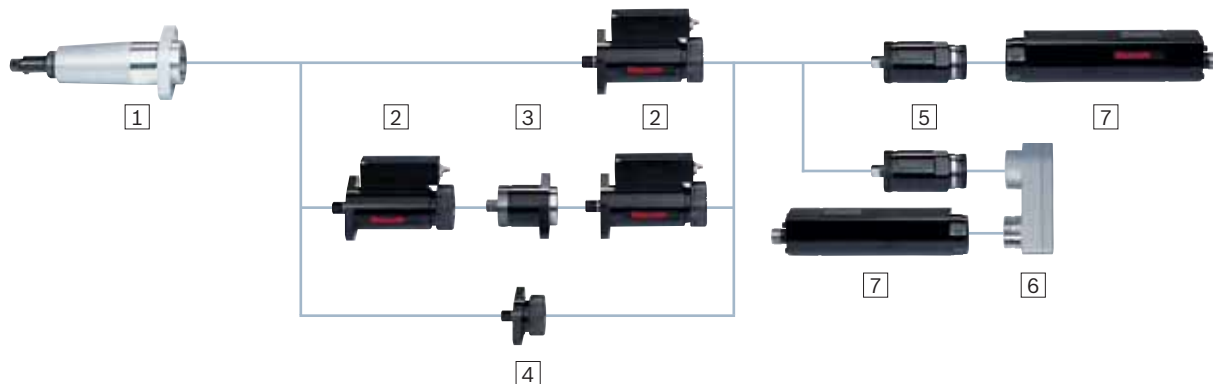

Note: You can find component dimensions and 3D/CAD data on the Internet at www.boschrexroth.com/tightening





Spindle bearing size 3

Components



1 Spindle bearing	Code	G1B102	G2B152	G1A102	G1C102	G2A152	G2C152
	Order no.	0608800063	0608800065	0608800062	0608800072	0608800064	0608800073
	Max. torque	Nm 35	35	55	55	55	55
	Range of spring	mm 25	50	25	25	50	50
	Reduction	1	1	1	1	1	1
	Avg. efficiency	1	1	1	1	1	1
	Length A	mm 102	152	102	102	152	152
	Installation length	mm 112	162	112	112	162	162
	Weight	kg 0.33	0.41	0.33	0.33	0.41	0.41
2 Measurement transducer	Code	3DMC017	3DMC060	You can configure your tightening spindle with a redundant measurement transducer from the same type. Connect both measurement transducers with the adapter. For measurement transducer cables, see page 126.			
	Order no.	0608820112	0608820113				
	Nominal torque	Nm 17	60				
	Reduction	1	1				
	Avg. efficiency	1	1				
	Installation length	mm 118.6	118.6				
	Weight	kg 1	1				
3 Redundant adapter	Code	3AR	When configuring with a redundant measurement transducer, the adapter connects both measurement transducers.				
	Order no.	0608810021					
	Reduction	1					
	Avg. efficiency	1					
	Installation length	mm 57					
	Weight	kg 0.4					
4 Adapter	Code	3A	When configuring without a measurement transducer, the adapter connects the output drive and the planetary gearbox.				
	Order no.	0608810025					
	Reduction	1					
	Avg. efficiency	1					
	Installation length	mm 30.5					
	Weight	kg 0.3					

5 Planetary gearbox 	Code	3GE27	3GE67	
	Order no.	0 608 720 053	0 608 720 039	
	Reduction	27	67.4	
	Avg. efficiency	0.93	0.9	
	Installation length	mm	65.5	81.5
	Weight	kg	0.5	0.5
6 Transverse gearbox 	Code	3ULG		
	Order no.	0 608 810 037	The transverse gearbox shortens the length of your tightening spindle by the installation length of the EC motor plus the installation length of the transverse gearbox. The use of a transverse gearbox decreases the tightening spindle working area.	
	Reduction	1		
	Avg. efficiency	0.95		
	Installation length	mm		30.1
	Weight	kg		0.5
7 EC motor 	Code	EC303		
	Order no.	0 608 701 017		
	Installation length	mm	219	
	Weight	kg	1.3	

Side-by-side arrangement of tightening spindles (center-to-center distance)						
Number of tightening spindles		2	3	4	5	6
						
Min. circle diameter- $\varnothing d_{min}$ mm	G...	45	52	65	80	89

Tightening spindles size 3 Offset output drive



- ▶ Working range 1.7 – 51 Nm
- ▶ Max. output drive speed 740 rpm

Depending on the size, the actual components may differ from those in the illustration.

Features

- ▶ For tight hole templates
- ▶ Standard tool mounts
- ▶ Easy assembly due to flange connection
- ▶ Maintenance-free for 1 million full-load cycles

Tightening spindle		Offset output drive				Measure- ment transducer	Planetary gearbox	EC motor
Working range *	Max. output drive speed	Range of spring mm	Tool mount	Code	Order no.	Code/ Order no.	Code/ Order no.	Code/ Order no.
Nm	rpm							
1.7–14.5	740	50	3/8" square	VNS2A152	0608800629	3DMC017	3GE27	EC303
			1/4" quick-change chuck	VNS2B152	0608800630	0608820112	0608720053	0608701017
			3/8" square with centering pin	VNS2C152	0608800631			
	295	50	3/8" square	VNS2A152	0608800629	3DMC017	3GE67	
			1/4" quick-change chuck	VNS2B152	0608800630	0608820112	0608720039	
			3/8" square with centering pin	VNS2C152	0608800631			
6–29	740	50	3/8" square	VNS2A152	0608800629	3DMC060	3GE27	EC303
			1/4" quick-change chuck	VNS2B152	0608800630	0608820113	0608720053	0608701017
			3/8" square with centering pin	VNS2C152	0608800631			
6–35	295	50	1/4" quick-change chuck	VNS2B152	0608800630	3DMC060 0608820113	3GE67 0608720039	EC303 0608701017
6–51	295	50	3/8" square	VNS2A152	0608800629	3DMC060	3GE67	EC303
		50	3/8" square with centering pin	VNS2C152	0608800631	0608820113	0608720039	0608701017





* Accuracy is limited if operating below the working range.

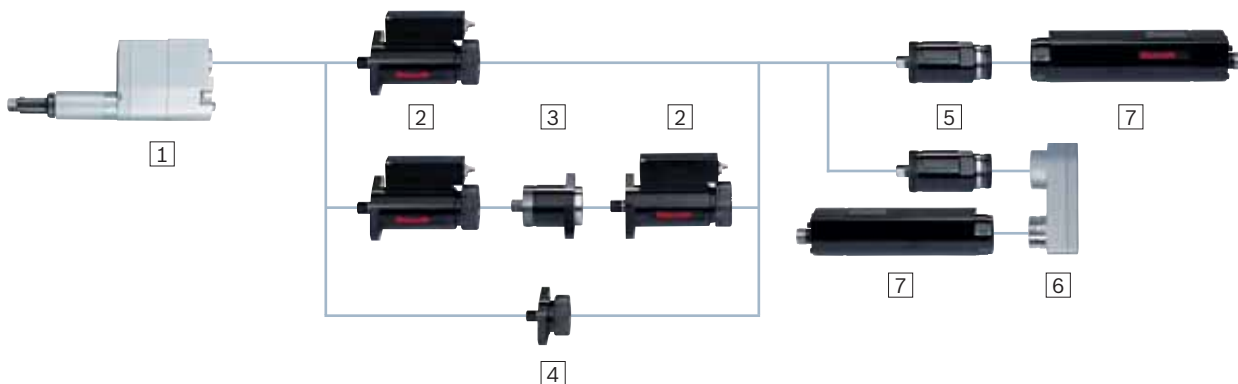

Note: You can find component dimensions and 3D/CAD data on the Internet at www.boschrexroth.com/tightening





Offset output drive size 3

Components



1 Offset output drive	Code	VNS2B152	VNS2A152	VNS2C152
	Order no.	0 608 800 630	0 608 800 629	0 608 800 631
	Max. torque	Nm 35	55	55
	Range of spring	mm 50	50	50
	Reduction	1	1	1
	Avg. efficiency	0.93	0.93	0.93
	Length A	mm 152	152	152
	Installation length	mm 240	240	240
	Weight	kg 1.2	1.2	1.2
2 Measurement transducer	Code	3DMC017	3DMC060	
	Order no.	0 608 820 112	0 608 820 113	You can configure your tightening spindle with a redundant measurement transducer from the same type. Connect both measurement transducers with the adapter. For measurement transducer cables, see page 126.
	Nominal torque	Nm 17	60	
	Reduction	1	1	
	Avg. efficiency	1	1	
	Installation length	mm 118.6	118.6	
	Weight	kg 1	1	
3 Redundant adapter	Code	3AR		
	Order no.	0 608 810 021		When configuring with a redundant measurement transducer, the adapter connects both measurement transducers.
	Reduction	1		
	Avg. efficiency	1		
	Installation length	mm 57		
	Weight	kg 0.4		
4 Adapter	Code	3A		
	Order no.	0 608 810 025		When configuring without a measurement transducer, the adapter connects the output drive and the planetary gearbox.
	Reduction	1		
	Avg. efficiency	1		
	Installation length	mm 30.5		
	Weight	kg 0.3		

5 Planetary gearbox 	Code	3GE27	3GE67	
	Order no.	0608720053	0608720039	
	Reduction	27	67.4	
	Avg. efficiency	0.93	0.9	
	Installation length	mm	65.5	81.5
	Weight	kg	0.5	0.5
6 Transverse gearbox 	Code	3ULG		
	Order no.	0608810037	The transverse gearbox shortens the length of your tightening spindle by the installation length of the EC motor plus the installation length of the transverse gearbox.	
	Reduction	1	The use of a transverse gearbox decreases the tightening spindle working area.	
	Avg. efficiency	0.95		
	Installation length	mm	30.1	
	Weight	kg	0.5	
7 EC motor 	Code	EC303		
	Order no.	0608701017		
	Installation length	mm	219	
	Weight	kg	1.3	

Side-by-side arrangement of tightening spindles (center-to-center distance)						
Number of tightening spindles		2	3	4	5	6
						
Min. circle diameter- \varnothing d _{min} mm	VNS2...152	29	33.5	41	49.5	58

Tightening spindles size 3 Offset output drive with integrated measurement transducer



- ▶ Working range 1.6 – 53 Nm
- ▶ Max. output drive speed 740 rpm

Depending on the size, the actual components may differ from those in the illustration.

Features

- ▶ Reduced center-to-center distances
- ▶ Torque measurement directly at the bolt
- ▶ Proximity switching digital measurement transfer
- ▶ Efficiency fluctuations do not affect measurements

Tightening spindle		Offset output drive with integrated measurement transducer				Planetary gearbox	EC motor
Working range *	Max. output drive speed	Range of spring	Tool mount	Code	Order no.	Code/ Order no.	Code/ Order no.
Nm	rpm	mm					
1.6–16	740	50	3/8" square	3VMC017	0608801009	3GE27 0608720053	EC303 0608701017
	295	50	3/8" square	3VMC017	0608801009	3GE67 0608720039	
6–29	740	50	3/8" square	3VMC035	0608801010	3GE27 0608720053	EC303 0608701017
6–33	295	50	3/8" square	3VMC035	0608801010	3GE67 0608720039	EC303 0608701017
6–53	295	50	3/8" square	3VMC060	0608801011	3GE67 0608720039	EC303 0608701017



* Accuracy is limited if operating below the working range.



Note: You can find component dimensions and 3D/CAD data on the Internet at www.boschrexroth.com/tightening

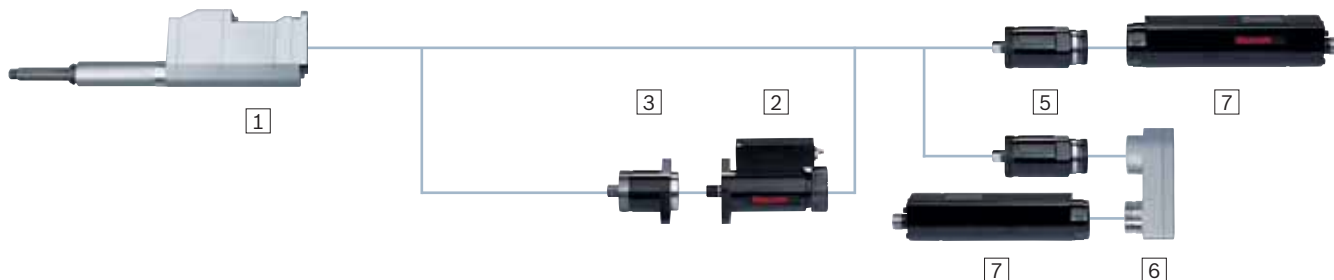



Offset output drive with integrated measurement transducer size 3

Components



1 Offset output drive with integrated measurement transducer	Code	3VMC017	3VMC035	3VMC060
	Order no.	0608801009	0608801010	0608801011
	Max. torque	Nm 17	35	60
	Range of spring	mm 50	50	50
	Reduction	1	1	1
	Avg. efficiency	0.93	0.93	0.93
	Length A	mm 152	152	152
	Installation length	mm 311	311	311
	Weight	kg 3.4	3.4	3.4
	Nominal torque measurement transducer	Nm 17	35	60
2 Measurement transducer	Code	3DMC017	3DMC060	
	Order no.	0608820112	0608820113	You can configure your tightening spindle with a redundant measurement transducer from the same type. Connect both measurement transducers with the adapter. For measurement transducer cables, see page 126.
	Nominal torque	Nm 17	60	
	Reduction	1	1	
	Avg. efficiency	1	1	
	Installation length	mm 118.6	118.6	
	Weight	kg 1	1	
3 Redundant adapter	Code	3AR		
	Order no.	0608810021		When configuring with a redundant measurement transducer, the adapter connects the output drive and the planetary gearbox.
	Reduction	1		
	Avg. efficiency	1		
	Installation length	mm 57		
	Weight	kg 0.4		

5 Planetary gearbox	Code	3GE27	3GE67	
	Order no.	0608720053	0608720039	
	Reduction	27	67.4	
	Avg. efficiency	0.93	0.9	
	Installation length	mm	65.5	
	Weight	kg	0.5	
			81.5	
			0.5	
6 Transverse gearbox	Code	3ULG		
	Order no.	0608810037	The transverse gearbox shortens the length of your tightening spindle by the installation length of the EC motor plus the installation length of the transverse gearbox. The use of a transverse gearbox decreases the tightening spindle working area.	
	Reduction	1		
	Avg. efficiency	0.95		
	Installation length	mm		30.1
	Weight	kg		0.5
7 EC motor	Code	EC303		
	Order no.	0608701017		
	Installation length	mm	219	
	Weight	kg	1.3	

Side-by-side arrangement of tightening spindles (center-to-center distance)						
Number of tightening spindles		2	3	4	5	6
						
Min. circle diameter- \varnothing d _{min} mm	3VMC...	31	36	44	53	62

Tightening spindles size 3 Angle head



- ▶ Working range 1.7 – 90 Nm
- ▶ Max. output drive speed 705 rpm

Depending on the size, the actual components may differ from those in the illustration.

Features

- ▶ For restricted accessibility
- ▶ Precision tothing for high torque accuracy
- ▶ Incremental positioning
- ▶ Integrated fastening flanges
- ▶ With integrated measurement transducer on request

Tightening spindle		Angle head			Measurement transducer	Planetary gearbox	EC motor
Working range *	Max. output drive speed Nm rpm	Tool mount	Code	Order no.	Code/ Order no.	Code/ Order no.	Code/ Order no.
1.7–16	705	3/8" square	3W027	0608810042	3DMC017 0608820112	3GE27 0608720053	EC303 0608701017
	280	3/8" square	3W027	0608810042	3DMC017 0608820112	3GE67 0608720039	
	705	3/8" square	3W050	0608810043	3DMC017 0608820112	3GE27 0608720053	
	280	3/8" square	3W050	0608810043	3DMC017 0608820112	3GE67 0608720039	
2.6–25	705	1/2" square	3W090	0608810044	3DMC017 0608820112	3GE27 0608720053	EC303 0608701017
	280	1/2" square	3W090	0608810044	3DMC017 0608820112	3GE67 0608720039	
6–27	705	3/8" square	3W027	0608810042	3DMC060 0608820113	3GE27 0608720053	EC303 0608701017
	280	3/8" square	3W027	0608810042	3DMC060 0608820113	3GE67 0608720039	
6–32	705	3/8" square	3W050	0608810043	3DMC060 0608820113	3GE27 0608720053	EC303 0608701017
6–50	280	3/8" square	3W050	0608810043	3DMC060 0608820113	3GE67 0608720039	EC303 0608701017
9–53	440	1/2" square	3W090	0608810044	3DMC060 0608820113	3GE27 0608720053	EC303 0608701017
9–90	175	1/2" square	3W090	0608810044	3DMC060 0608820113	3GE67 0608720039	EC303 0608701017

*Accuracy is limited if operating below the working range.

To ensure troublefree operation, the angle head must always be operated with an output drive axial compensator, e.g. spindle bearing. For an output drive axial compensator, the following angle head/spindle bearing combinations are possible:

3W027 (0 608 810 042) – spindle bearing size 3 (catalog page 30)

3W050 (0 608 810 043) – spindle bearing size 3 (catalog page 30)





3W090 (0 608 810 044) – spindle bearing size 4 (catalog page 40)

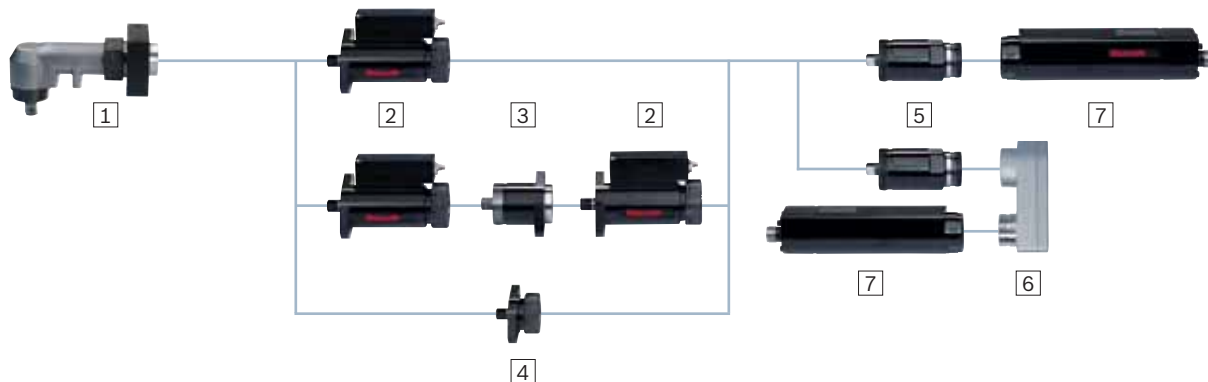

Note: You can find component dimensions and 3D/CAD data on the Internet at www.boschrexroth.com/tightening

Angle head size 3





Components



1 Angle head 	Code		3W027	3W050	3W090
	Order no.		0608810042	0608810043	0608810044
	Max. torque	Nm	27	50	90
	Reduction		1.05	1.05	1.67
	Avg. efficiency		0.95	0.95	0.95
	Installation length	mm	85.6	125.6	125.6
	Weight	kg	1	1.42	1.7
2 Measurement transducer 	Code		3DMC017	3DMC060	
	Order no.		0608820112	0608820113	You can configure your tightening spindle with a redundant measurement transducer from the same type. Connect both measurement transducers with the adapter. For measurement transducer cables, see page 126.
	Nominal torque	Nm	17	60	
	Reduction		1	1	
	Avg. efficiency		1	1	
	Installation length	mm	118.6	118.6	
Weight	kg	1	1		
3 Redundant adapter 	Code		3AR		When configuring with a redundant measurement transducer, the adapter connects both measurement transducers.
	Order no.		0608810021		
	Reduction		1		
	Avg. efficiency		1		
	Installation length	mm	57		
Weight	kg	0.4			
4 Adapter 	Code		3A		When configuring without a measurement transducer, the adapter connects the output drive and the planetary gearbox.
	Order no.		0608810025		
	Reduction		1		
	Avg. efficiency		1		
	Installation length	mm	30.5		
Weight	kg	0.3			

	5 Planetary gearbox	Code	3GE27	3GE67	
		Order no.	0 608 720 053	0 608 720 039	
		Reduction	27	67.4	
		Avg. efficiency	0.93	0.9	
		Installation length	mm	65.5	81.5
		Weight	kg	0.5	0.5
	6 Transverse gearbox	Code	3ULG		
		Order no.	0 608 810 037	The transverse gearbox shortens the length of your tightening spindle by the installation length of the EC motor plus the installation length of the transverse gearbox. The use of a transverse gearbox decreases the tightening spindle working area.	
		Reduction	1		
		Avg. efficiency	0.95		
		Installation length	mm		30.1
		Weight	kg		0.5
	7 EC motor	Code	EC303		
		Order no.	0 608 701 017		
		Installation length	mm	219	
		Weight	kg	1.3	

Side-by-side arrangement of tightening spindles (center-to-center distance)

Number of tightening spindles		2	3	4	5	6
						
Min. circle diameter- $\varnothing d_{min}$ mm	3W027	29	34	41	50	58
	3W050	35	40	50	60	70
	3W090	45	52	64	78	90

Tightening spindles size 3 Feed output drive



- ▶ Working range 1.7 – 53 Nm
- ▶ Max. output drive speed 740 rpm

Depending on the size, the actual components may differ from those in the illustration.

Features

- ▶ Integrated feed movement
- ▶ In connection with automatic bolt supply
- ▶ Standard tool mounts and compressed air connections
- ▶ Easy assembly due to flange connection
- ▶ Maintenance-free for 1 million full-load cycles

Tightening spindle		Feed output drive				Measure- ment transducer	Planetary gearbox	EC motor
Working range *	Max. output drive speed rpm	Stroke mm	Tool mount	Code	Order no.	Code/ Order no.	Code/ Order no.	Code/ Order no.
1.7–15	740	200	3/8" square	3S1	0608800610	3DMC017 0608820112	3GE27 0608720053	EC303 0608701017
	295	200	3/8" square	3S1	0608800610	3DMC017 0608820112	3GE67 0608720039	
	740	200	1/4" square	3S2	0608800611	3DMC017 0608820112	3GE27 0608720053	
	295	200	1/4" square	3S2	0608800611	3DMC017 0608820112	3GE67 0608720039	
6–20	295	200	1/4" square	3S2	0608800611	3DMC060 0608820113	3GE67 0608720039	EC303 0608701017
6–20	740	200	1/4" square	3S2	0608800611	3DMC060 0608820113	3GE27 0608720053	EC303 0608701017
6–30	740	200	3/8" square	3S1	0608800610	3DMC060 0608820113	3GE27 0608720053	EC303 0608701017
6–53	295	200	3/8" square	3S1	0608800610	3DMC060 0608820113	3GE67 0608720039	EC303 0608701017





* Accuracy is limited if operating below the working range.

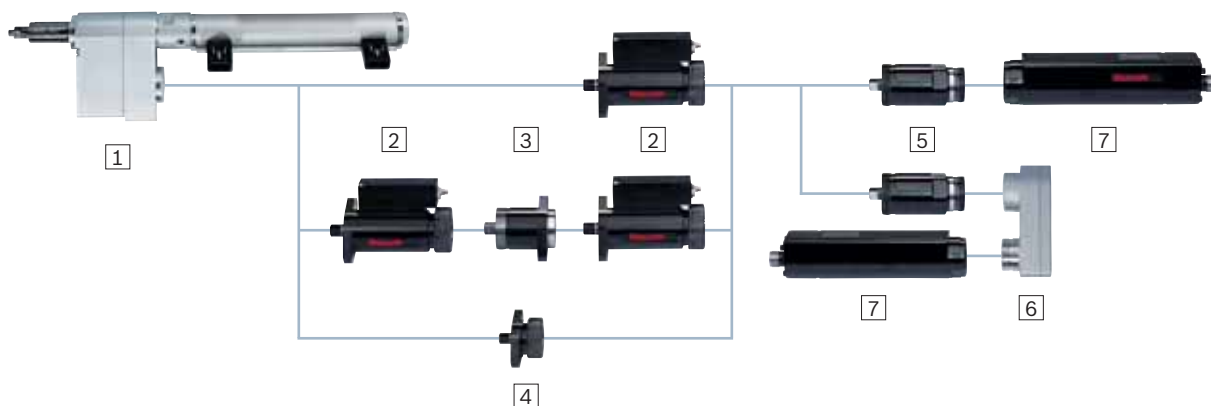

Note: You can find component dimensions and 3D/CAD data on the Internet at www.boschrexroth.com/tightening

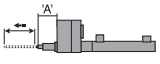
Feed output drive size 3





Components



1 Feed output drive	Code	3S2	3S1	
	Order no.	0608800 611	0608800 610	
	Max. torque	Nm 20	55	
	Stroke	mm 200	200	
	Max. air pressure	bar 4	4	
	Reduction	1	1	
	Avg. efficiency	0.93	0.93	
	Length A	mm 97	97	
	Installation length	mm 204	204	
	Weight	kg 3.5	3.5	
2 Measurement transducer	Code	3DMC017	3DMC060	
	Order no.	0608820 112	0608820 113	You can configure your tightening spindle with a redundant measurement transducer from the same type. Connect both measurement transducers with the adapter. For measurement transducer cables, see page 126.
	Nominal torque	Nm 17	60	
	Reduction	1	1	
	Avg. efficiency	1	1	
	Installation length	mm 118.6	118.6	
	Weight	kg 1	1	
3 Redundant adapter	Code	3AR		
	Order no.	0608810 021		When configuring with a redundant measurement transducer, the adapter connects both measurement transducers.
	Reduction	1		
	Avg. efficiency	1		
	Installation length	mm 57		
	Weight	kg 0.4		
4 Adapter	Code	3A		
	Order no.	0608810 025		When configuring without a measurement transducer, the adapter connects the output drive and the planetary gearbox.
	Reduction	1		
	Avg. efficiency	1		
	Installation length	mm 30.5		
	Weight	kg 0.3		

5 Planetary gearbox	Code	3GE27	3GE67	
	Order no.	0 608 720 053	0 608 720 039	
	Reduction	27	67.4	
	Avg. efficiency	0.93	0.9	
	Installation length	mm	65.5	81.5
	Weight	kg	0.5	0.5
6 Transverse gearbox	Code	3ULG		
	Order no.	0 608 810 037	The transverse gearbox shortens the length of your tightening spindle by the installation length of the EC motor plus the installation length of the transverse gearbox. The use of a transverse gearbox decreases the tightening spindle working area.	
	Reduction	1		
	Avg. efficiency	0.95		
	Installation length	mm		30.1
	Weight	kg		0.5
7 EC motor	Code	EC303		
	Order no.	0 608 701 017		
	Installation length	mm	219	
	Weight	kg	1.3	

Side-by-side arrangement of tightening spindles (center-to-center distance)

Number of tightening spindles	2	3	4	5	6
					
Min. circle diameter- \varnothing d_{min} mm	3S... 49	56.5	69.5	83.5	98

Tightening spindles size 4 Spindle bearing



- ▶ Working range 6–150 Nm
- ▶ Max. output drive speed 1000 rpm

Depending on the size, the actual components may differ from those in the illustration.

Features

- ▶ Various lengths with axial compensator
- ▶ Standard tool mounts
- ▶ Maximum efficiency
- ▶ Easy assembly due to flange connection
- ▶ Maintenance-free for 1 million full-load cycles





Tightening spindle		Spindle bearing				Measurement transducer	Planetary gearbox	EC motor		
Working range *	Max. output drive speed	Range of spring mm / Max. spring force N	Tool mount	Code	Order no.	Code / Order no.	Code / Order no.	Code / Order no.		
Nm	rpm									
6-52	1000	25 / 90.2	1/2" square	GK1A156	0 608 800 031	4DMC060 0 608 820 114	4GE19 0 608 720 056	EC304 0 608 701 018		
			7/16" quick-change chuck	GK1B156	0 608 800 020					
			1/2" square with centering pin	GK1C156	0 608 800 001					
		50 / 93.3	1/2" square	GK2A181/251	0 608 800 006 / 048					
			7/16" quick-change chuck	GK2B181/251	0 608 800 008 / 049					
			1/2" square with centering pin	GK2C181/251	0 608 800 021 / 050					
			1/2" square	GL2A319	0 608 800 056					
			7/16" quick-change chuck	GL2B319	0 608 800 057					
			1/2" square with centering pin	GL2C319	0 608 800 027					
		6-56	340	25 / 93.3	1/2" square	GK1A156	0 608 800 031	4DMC060 0 608 820 114	4GE59 0 608 720 040	EC304 0 608 701 018
					7/16" quick-change chuck	GK1B156	0 608 800 020			
					1/2" square with centering pin	GK1C156	0 608 800 001			
50 / 93.3	1/2" square			GK2A181/251	0 608 800 006 / 048					
	7/16" quick-change chuck			GK2B181/251	0 608 800 008 / 049					
	1/2" square with centering pin			GK2C181/251	0 608 800 021 / 050					
	1/2" square			GL2A319	0 608 800 056					
	7/16" quick-change chuck			GL2B319	0 608 800 057					
	1/2" square with centering pin			GL2C319	0 608 800 027					
15-150	340			25 / 93.3	1/2" square	GK1A156	0 608 800 031	4DMC160 0 608 820 115	4GE59 0 608 720 040	EC304 0 608 701 018
					7/16" quick-change chuck	GK1B156	0 608 800 020			
					1/2" square with centering pin	GK1C156	0 608 800 001			
		50 / 93.3	1/2" square	GK2A181/251	0 608 800 006 / 048					
			7/16" quick-change chuck	GK2B181/251	0 608 800 008 / 049					
			1/2" square with centering pin	GK2C181/251	0 608 800 021 / 050					
			1/2" square	GL2A319	0 608 800 056					
			7/16" quick-change chuck	GL2B319	0 608 800 057					
			1/2" square with centering pin	GL2C319	0 608 800 027					

* Accuracy is limited if operating below the working range.

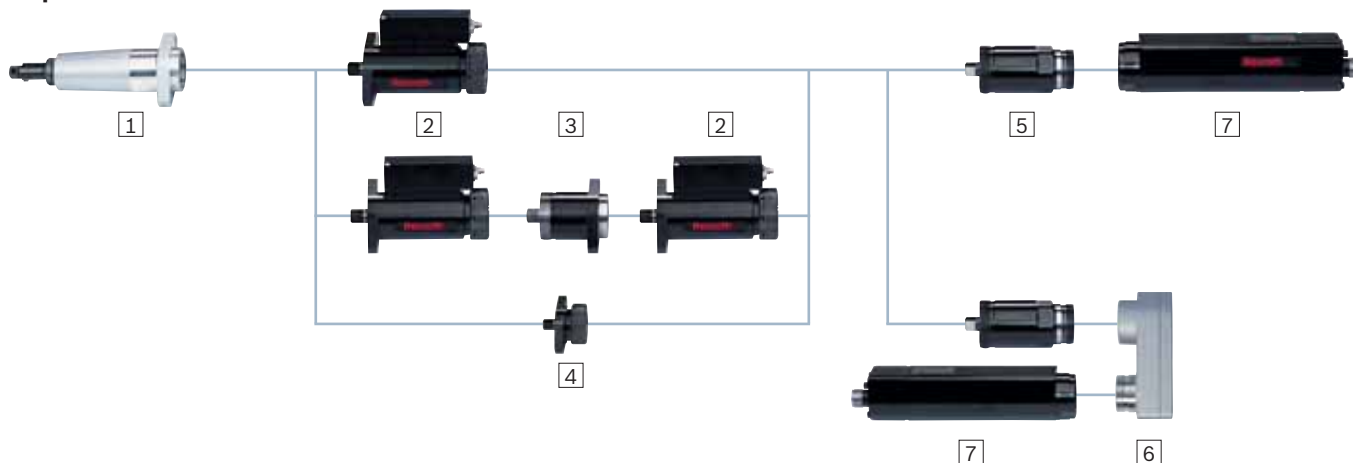
Note: You can find component dimensions and 3D/CAD data on the Internet at www.boschrexroth.com/tightening





Spindle bearing size 4 Components







1 Spindle bearing 	Code	GK1A156	GK1B156	GK1C156	GK2A181	GK2B181	GK2C181	
	Order no.	0608800031	0608800020	0608800001	0608800006	0608800008	0608800021	
	Max. torque	Nm	150	150	150	150	150	
	Range of spring	mm	25	25	25	50	50	
	Reduction		1	1	1	1	1	
	Avg. efficiency		1	1	1	1	1	
	Length A	mm	156	156	156	181	181	
	Installation length	mm	170	170	170	195	195	
Weight	kg	0.9	0.9	0.9	1	1	1	
1 Spindle bearing 	Code	GK2A251	GK2B251	GK2C251	GK2A251	GK2B251	GK2C251	
	Order no.	0608800048	0608800049	0608800050	0608800056	0608800057	0608800027	
	Max. torque	Nm	150	150	150	150	150	
	Range of spring	mm	50	50	50	50	50	
	Reduction		1	1	1	1	1	
	Avg. efficiency		1	1	1	1	1	
	Length A	mm	251	251	251	319	319	
	Installation length		265	265	265	333	333	
Weight	kg	1	1	1	2.1	2.1	2.1	
2 Measure-ment transducer 	Code	4DMC060	4DMC160					
	Order no.	0608820114	0608820115					
	Max. torque	Nm	60	160				
	Reduction		1	1				
	Avg. efficiency		1	1				
	Length	mm	182	182				
	Installation length A	mm	122	122				
Weight	kg	1.6	1.6					
3 Redundant adapter 	Code	4AR						
	Order no.	0608810022						
	Reduction		1					
	Avg. efficiency		1					
	Installation length	mm	65					
Weight	kg	0.8						

You can configure your tightening spindle with a redundant measurement transducer from the same type. Connect both measurement transducers with the adapter. For measurement transducer cables, see page 126.

When configuring with a redundant measurement transducer, the adapter connects both measurement transducers.

4 Adapter 	Code	4A		
	Order no.	0 608 810 026		When configuring without a measurement transducer, the adapter connects the output drive and the planetary gearbox.
	Reduction	1		
	Avg. efficiency	1		
	Installation length	mm	26.5	
Weight	kg	0.4		
5 Planetary gearbox 	Code	4GE19	4GE59	
	Order no.	0 608 720 056	0 608 720 040	
	Reduction	19.3	58.6	
	Avg. efficiency	0.93	0.9	
	Installation length	mm	82.9	105.5
Weight	kg	0.7	1.1	
6 Transverse gearbox 	Code	4ULG		
	Order no.	0 608 810 038		The transverse gearbox shortens the length of your tightening spindle by the installation length of the EC motor plus the installation length of the transverse gearbox. The use of a transverse gearbox decreases the tightening spindle working area.
	Reduction	1		
	Avg. efficiency	0.95		
	Installation length	mm	41.3	
Weight [kg]	kg	1.4		
7 EC motor 	Code	EC304		
	Order no.	0 608 701 018		
	Installation length	mm	247	
	Weight	kg	2.7	

Side-by-side arrangement of tightening spindles (center-to-center distance)

Number of tightening spindles	2	3	4	5	6
					
Min. circle diameter- $\varnothing d_{\min}$ mm	G... 59	69	89	109	119

Tightening spindles size 4 Offset output drive



- ▶ Working range 6–340 Nm
- ▶ Max. output drive speed 1000 rpm

Depending on the size, the actual components may differ from those in the illustration.

Features

- ▶ For tight hole templates, side-by-side arrangement with small center-to-center distances
- ▶ Standard tool mounts
- ▶ Easy assembly due to flange connection
- ▶ Maintenance-free for 1 million full-load cycles

Tightening spindle		Offset output drive				Measurement transducer	Planetary gearbox	EC motor
Working range *	Max. output drive speed rpm	Range of spring mm	Tool mount	Code	Order no.	Code/Order no.	Code/Order no.	Code/Order no.
6–51	1000	50	1/2" square	VNK2A181/251	0 608 800 632 / 633	4DMC060 0 608 820 114	4GE19 0 608 720 056	EC304 0 608 701 018
			7/16" change chuck	VNK2B181/251	0 608 800 634 / 635			
			1/2" square with centering pin	VNK2C181/251	0 608 800 636 / 637			
			1/2" square	VNL2A319	0 608 800 639			
			1/2" square with centering pin	VNL2C319	0 608 800 643			
	340	50	1/2" square	VNK2A181/251	0 608 800 632 / 633	4DMC060 0 608 820 114	4GE59 0 608 720 040	
			7/16" change chuck	VNK2B181/251	0 608 800 634 / 635			
			1/2" square with centering pin	VNK2C181/251	0 608 800 636 / 637			
			1/2" square	VNL2A319	0 608 800 639			
			1/2" square with centering pin	VNL2C319	0 608 800 643			
8–75	740	50	3/4" square	VUK2D242	0 608 PE0 588	4DMC060 0 608 820 114	4GE19 0 608 720 056	EC304 0 608 701 018
	240	50	3/4" square	VUK2D242	0 608 PE0 588	4DMC060 0 608 820 114	4GE59 0 608 720 040	
13–120	410	50	3/4" square	VUK2D186	0 608 800 644	4DMC060 0 608 820 114	4GE19 0 608 720 056	EC304 0 608 701 018
				VUL2D290	0 608 800 645			
13–130	135	50	3/4" square	VUK2D186	0 608 800 644	4DMC060 0 608 820 114	4GE59 0 608 720 040	EC304 0 608 701 018
				VUL2D290	0 608 800 645			
15–145	340	50	1/2" square	VNK2A181/251	0 608 800 632 / 633	4DMC160 0 608 820 115	4GE59 0 608 720 040	EC304 0 608 701 018
			7/16" quick-change chuck	VNK2B181/251	0 608 800 634 / 635			
			1/2" square with centering pin	VNK2C181/251	0 608 800 636 / 637			
			1/2" square	VNL2A319	0 608 800 639			
			1/2" square with centering pin	VNL2C319	0 608 800 643			
20–200	240	50	3/4" square	VUK2D242	0 608 PE0 588	4DMC160 0 608 820 115	4GE59 0 608 720 040	EC304 0 608 701 018
35–340	135	50	3/4" square	VUK2D186	0 608 800 644	4DMC160 0 608 820 115	4GE59 0 608 720 040	EC304 0 608 701 018
				VUL2D290	0 608 800 645			





* Accuracy is limited if operating below the working range.



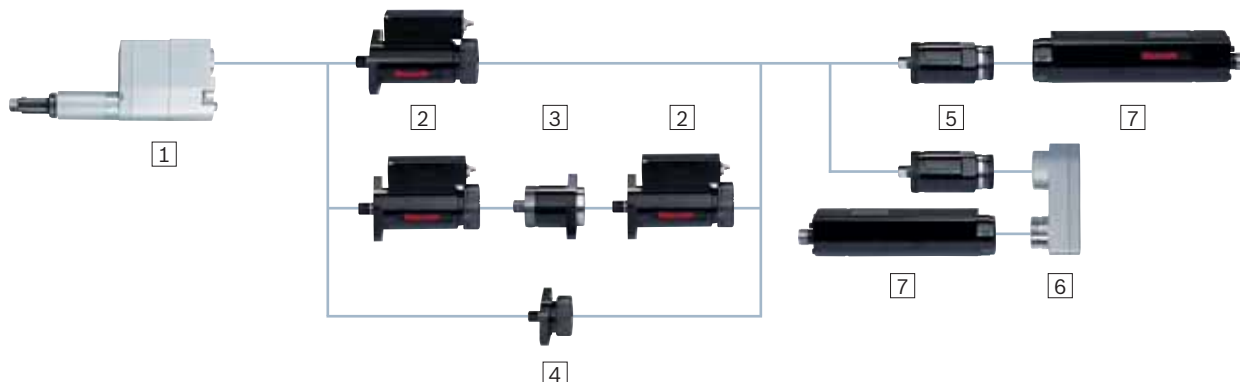

Note: You can find component dimensions and 3D/CAD data on the Internet at www.boschrexroth.com/tightening

Offset output drive size 4





Components



1 Offset output drive 	Code		VNK2A181	VNK2B181	VNK2C181	VNK2A251	VNK2B251	VNK2C251				
	Order no.		0608800632	0608800634	0608800636	0608800633	0608800635	0608800637				
	Max. torque	Nm	150	150	150	150	150	150				
	Range of spring	mm	50	50	50	50	50	50				
	Reduction		1	1	1	1	1	1				
	Avg. efficiency		0.91	0.91	0.91	0.91	0.91	0.91				
	Length A	mm	182	182	182	252	252	252				
	Installation length	mm	309	309	309	379	379	379				
	Weight	kg	3.4	3.4	3.4	4.0	4.0	4.0				
1 Offset output drive 	Code		VNL2A181	VNL2C181	VUK2D242	VUK2D186	VUL2D290					
	Order no.		0608800639	0608800643	0608PE0588	0608800644	0608800645					
	Max. torque	Nm	150	150	200	340	340					
	Range of spring	mm	50	50	50	50	50					
	Reduction		1	1	1.46	2.56	2.56					
	Avg. efficiency		0.91	0.91	0.92	0.92	0.92					
	Length A	mm	182	182	182	252	252					
	Installation length		448	448	370	354	458					
Weight	kg	4.5	4.5	5.8	7.5	8.5						
2 Measurement transducer 	Code		4DMC060	4DMC160								
	Order no.		0608820114	0608820115								
	Max. torque	Nm	60	160	You can configure your tightening spindle with a redundant measurement transducer from the same type. Connect both measurement transducers with the adapter. For measurement transducer cables, see page 126.							
	Reduction		1	1								
	Avg. efficiency		1	1								
	Length	mm	182	182								
	Installation length A	mm	122	122								
	Weight	kg	1.6	1.6								
3 Redundant adapter 	Code		4AR									
	Order no.		0608810022									
	Reduction		1	When configuring with a redundant measurement transducer, the adapter connects both measurement transducers.								
	Avg. efficiency		1									
	Installation length	mm	65									
Weight	kg	0.8										

4 Adapter 	Code	4A		
	Order no.	0 608 810 026		When configuring without a measurement transducer, the adapter connects the output drive and the planetary gearbox.
	Reduction	1		
	Avg. efficiency	1		
	Installation length	mm	26.5	
Weight	kg	0.4		
5 Planetary gearbox 	Code	4GE19	4GE59	
	Order no.	0 608 720 056	0 608 720 040	
	Reduction	19.3	58.6	
	Avg. efficiency	0.93	0.9	
	Installation length	mm	82.9	105.5
Weight	kg	0.7	1.1	
6 Transverse gearbox 	Code	4ULG		
	Order no.	0 608 810 038		The transverse gearbox shortens the length of your tightening spindle by the installation length of the EC motor plus the installation length of the transverse gearbox. The use of a transverse gearbox decreases the tightening spindle working area.
	Reduction	1		
	Avg. efficiency	0.95		
	Installation length	mm	41.3	
Weight [kg]	kg	1.4		
7 EC motor 	Code	EC304		
	Order no.	0 608 701 018		
	Installation length	mm	247	
	Weight	kg	2.7	

Side-by-side arrangement of tightening spindles (center-to-center distance)

Number of tightening spindles		2	3	4	5	6
						
Min. circle diameter- \varnothing d _{min} mm	VN...	44	51	63	75	88
	VU...	57	66	81	97	114
	VUK2D242	48	56	68	82	96

Tightening spindles size 4 Offset output drive with integrated measurement transducer



- ▶ Working range 15–342 Nm
- ▶ Max. output drive speed 1000 rpm

Depending on the size, the actual components may differ from those in the illustration.

Features

- ▶ Reduced center-to-center distances
- ▶ Torque measurement directly at the bolt
- ▶ Proximity switching digital measurement transfer
- ▶ Efficiency fluctuations do not affect measurements

Tightening spindle		Offset output drive with integrated measurement transducer				Planetary gearbox	EC motor
Working range *	Max. output drive speed	Range of spring	Tool mount	Code	Order no.	Code/ Order no.	Code/ Order no.
Nm	rpm	mm					
15-47	1000	80	1/2" square	4VMC150	0608801004	4GE19	EC304
21-65	700	80	3/4" square	4VMC210	0608801005	0608720056	0608701018
36-117	410	80	3/4" square	4VMC360	0608801006		
15-142	340	80	1/2" square	4VMC150	0608801004	4GE59	
21-200	240	80	3/4" square	4VMC210	0608801005	0608720040	
36-342	135	80	3/4" square	4VMC360	0608801006		





* Accuracy is limited if operating below the working range.

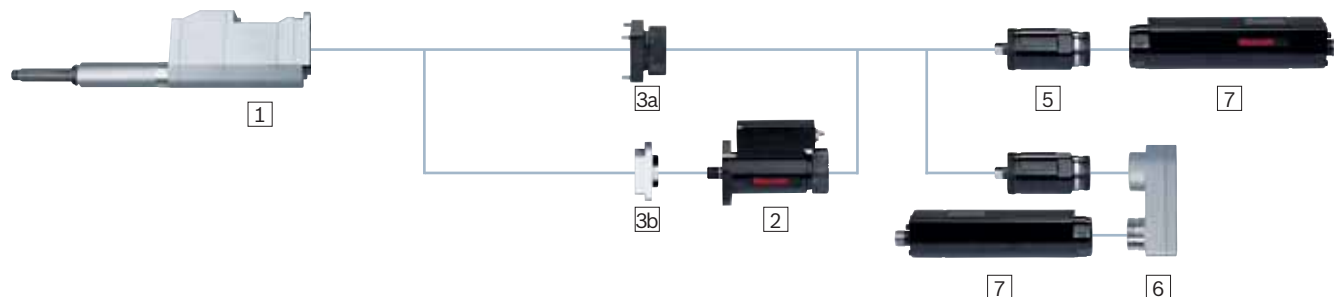

Note: You can find component dimensions and 3D/CAD data on the Internet at www.boschrexroth.com/tightening

Offset output drive with integrated measurement transducer





Components



1 Offset output drive with integrated measurement transducer 	Code	4VMC150	4VMC210	4VMC360	
	Order no.	0 608 801 004	0 608 801 005	0 608 801 006	
	Max. torque	Nm	150	210	360
	Range of spring	mm	80	80	80
	Reduction		1	1.46	2.56
	Avg. efficiency		0.92	0.92	0.92
	Length A	mm	242	252	246
	Installation length	mm	438	438	476
	Weight	kg	4.9	7.1	11.7
Nominal torque of measurement transducer	Nm	150	210	360	
2 Measurement transducer 	Code	4DMC060	4DMC160		
	Order no.	0 608 820 114	0 608 820 115	You can configure your tightening spindle with a redundant measurement transducer from the same type. Connect both measurement transducers with the adapter. For measurement transducer cables, see page 126.	
	Max. torque	Nm	60	160	
	Reduction		1	1	
	Avg. efficiency		1	1	
	Installation length	mm	122	122	
Weight	kg	1.6	1.6		
3a AVG adapter 	Code	4AVG			
	Order no.	0 608 801 008		The adapter connects the output drive and the planetary gearbox.	
	Reduction		1		
	Avg. efficiency		1		
	Installation length	mm	26.5		
Weight	kg	0.4			
3b AVR redundant adapter 	Code	4AVR			
	Order no.	0 608 801 007		When configuring an offset output drive with integrated measurement transducer and redundant measurement transducer, the adapter connects both components.	
	Reduction		1		
	Avg. efficiency		1		
	Installation length	mm	30.3		
Weight	kg	0.7			

5 Planetary gearbox	Code	4GE19	4GE59	
	Order no.	0608720056	0608720040	
	Reduction	19.3	58.6	
	Avg. efficiency	0.93	0.9	
	Installation length	mm	82.9	
	Weight	kg	0.7	
			105.5	
			1.1	
6 Transverse gearbox	Code	4ULG		
	Order no.	0608810038	The transverse gearbox shortens the length of your tightening spindle by the installation length of the EC motor plus the installation length of the transverse gearbox. The use of a transverse gearbox decreases the tightening spindle working area.	
	Reduction	1		
	Avg. efficiency	0.95		
	Installation length	mm		41.3
	Weight	kg		1.4
7 EC motor	Code	EC304		
	Order no.	0608701018		
	Installation length	mm	247	
	Weight	kg	2.7	

Side-by-side arrangement of tightening spindles (center-to-center distance)

Number of tightening spindles		2	3	4	5	6
						
Min. circle diameter- \varnothing d _{min} mm	4VMC150	44	51	63	75	88
	4VMC210	48	56	68	82	96
	4VMC360	57	66	81	97	114

Tightening spindles size 4 Angle head



- ▶ Working range 6–220 Nm
- ▶ Max. output drive speed 985 rpm

Depending on the size, the actual components may differ from those in the illustration.

Features

- ▶ For restricted accessibility
- ▶ Precision tothing for high torque accuracy
- ▶ Incremental positioning
- ▶ Integrated fastening flanges
- ▶ With integrated measurement transducer on request

Tightening spindle		Angle head			Measurement transducer	Planetary gearbox	EC motor
Working range *	Max. output drive speed	Tool mount	Code	Order no.	Code/ Order no.	Code/ Order no.	Code/ Order no.
Nm	rpm						
6–52	985	1/2" square	4W130	0608810045	4DMC060 0608820114	4GE19 0608720056	EC304 0608701018
6–56	320	1/2" square	4W130	0608810045	4DMC060 0608820114	4GE59 0608720040	
9–83	620	3/4" square	4W220	0608810046	4DMC060 0608820114	4GE19 0608720056	
9–90	204	3/4" square	4W220	0608810046	4DMC060 0608820114	4GE59 0608720040	
15–130	320	1/2" square	4W130	0608810045	4DMC160 0608820115	4GE59 0608720040	
24–220	200	3/4" square	4W220	0608810046	4DMC160 0608820115	4GE59 0608720040	

*Accuracy is limited if operating below the working range.





To ensure troublefree operation, the angle head must always be operated with an output drive axial compensator, e.g. spindle bearing. See page 17.

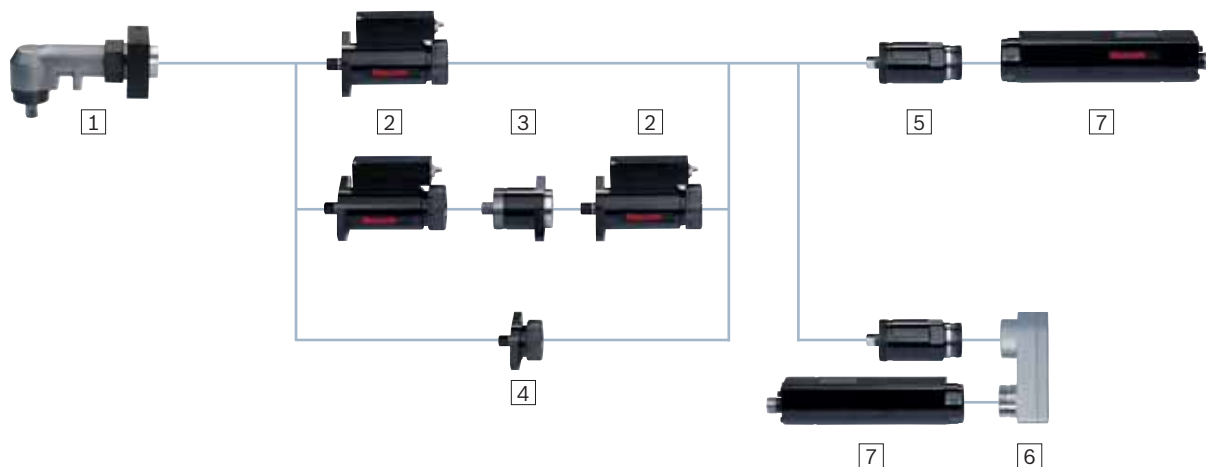

Note: You can find component dimensions and 3D/CAD data on the Internet at www.boschrexroth.com/tightening

Angle head size 4





Components



1 Angle head 	Code	4W130	4W220		
	Order no.		0 608 810 045	0 608 810 046	
	Max. torque	Nm	130	220	
	Reduction		1.05	1.67	
	Avg. efficiency		0.95	0.95	
	Installation length	mm	141.5	141.5	
	Weight	kg	2.8	3.2	
2 Measurement transducer 	Code	4DMC060	4DMC160		
	Order no.		0 608 820 114	0 608 820 115	You can configure your tightening spindle with a redundant measurement transducer from the same type. Connect both measurement transducers with the redundant adapter. For measurement transducer cables, see page 126.
	Nominal torque	Nm	60	160	
	Reduction		1	1	
	Avg. efficiency		1	1	
	Installation length	mm	122	122	
	Weight	kg	1.6	1.6	
3 Redundant adapter 	Code	4AR			
	Order no.		0 608 810 022	When configuring with a redundant measurement transducer, the adapter connects both measurement transducers.	
	Reduction		1		
	Avg. efficiency		1		
	Installation length	mm	65		
	Weight	kg	0.8		
4 Adapter 	Code	4A			
	Order no.		0 608 810 026	When configuring without a measurement transducer, the adapter connects the output drive and the planetary gearbox.	
	Reduction		1		
	Avg. efficiency		1		
	Installation length	mm	26.5		
	Weight	kg	0.4		

5 Planetary gearbox	Code	4GE19	4GE59
	Order no.	0 608 720 056	0 608 720 040
	Reduction	19.3	58.6
	Avg. efficiency	0.93	0.9
	Installation length	mm 82.9	105.5
	Weight	kg 0.7	1.1
6 Transverse gearbox	Code	4ULG	
	Order no.	0 608 810 038	The transverse gearbox shortens the length of your tightening spindle by the installation length of the EC motor plus the installation length of the transverse gearbox.
	Reduction	1	The use of a transverse gearbox decreases the tightening spindle working area.
	Avg. efficiency	0.95	
	Installation length	mm 41.3	
	Weight [kg]	kg 1.4	
7 EC motor	Code	EC304	
	Order no.	0 608 701 018	
	Installation length	mm 247	
	Weight	kg 2.7	

Side-by-side arrangement of tightening spindles (center-to-center distance)

Number of tightening spindles		2	3	4	5	6
						
Min. circle diameter- \varnothing d _{min}	4W130	47	55	67	80	94
mm	4W220	62	72	88	106	124

Tightening spindles size 4 Feed output drive



- ▶ Working range 6–136 Nm
- ▶ Max. output drive speed 1000 rpm

Depending on the size, the actual components may differ from those in the illustration.

Features

- ▶ Integrated feed movement
- ▶ In connection with automatic bolt supply
- ▶ Standard tool mounts and compressed air connections
- ▶ Easy assembly due to flange connection
- ▶ Maintenance-free for 1 million full-load cycles

Tightening spindle			Feed output drive			Measurement transducer	Planetary gearbox	EC motor
Working range *	Max. output drive speed	Stroke	Tool mount	Code	Order no.	Code/ Order no.	Code/ Order no.	Code/ Order no.
Nm	rpm	mm						
6–47	1000	200	1/2" square with centering pin	4S1	0 608 800 609	4DMC060 0 608 820 114	4GE19 0 608 720 056	EC304 0 608 701 018
6–51	340	200	1/2" square with centering pin	4S1	0 608 800 609	4DMC060 0 608 820 114	4GE59 0 608 720 040	
15–136	340	200	1/2" square with centering pin	4S1	0 608 800 609	4DMC060 0 608 820 114	4GE59 0 608 720 040	





* Accuracy is limited if operating below the working range.

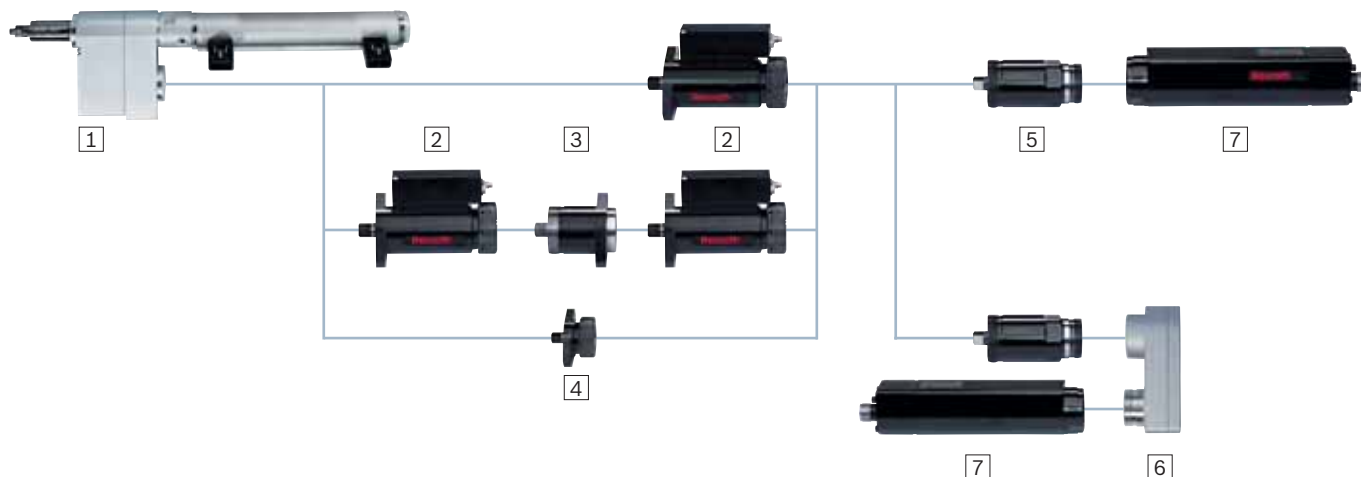

Note: You can find component dimensions and 3D/CAD data on the Internet at www.boschrexroth.com/tightening

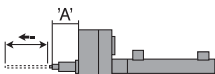
Feed output drive size 4





Components



1 Feed output drive 	Code	4S1			
	Order no.	0608800609			
	Max. torque	Nm	150		
	Stroke	mm	200		
	Max. air pressure	bar	4		
	Reduction		1		
	Avg. efficiency		0.93		
	Length A	mm	101		
	Installation length	mm	219		
	Weight	kg	6.6		
2 Measurement transducer 	Code	4DMC060	4DMC160		
	Order no.	0608820114	0608820115	You can configure your tightening spindle with a redundant measurement transducer from the same type. Connect both measurement transducers with the redundant adapter. For measurement transducer cables, see page 126.	
	Nominal torque	60 Nm	160		
	Reduction	1	1		
	Avg. efficiency	1	1		
	Installation length	mm	122 mm		122
	Weight	kg	1.6 kg		1.6
3 Redundant adapter 	Code	4AR			
	Order no.	0608810022		When configuring with a redundant measurement transducer, the adapter connects both measurement transducers.	
	Reduction	1			
	Avg. efficiency	1			
	Installation length	mm	65		
	Weight	kg	0.8		
4 Adapter 	Code	4A			
	Order no.	0608810026		When configuring without a measurement transducer, the adapter connects the output drive and the planetary gearbox.	
	Reduction	1			
	Avg. efficiency	1			
	Installation length	mm	26.5		
	Weight	kg	0.4		

5 Planetary gearbox	Code	4GE19	4GE59
	Order no.	0 608 720 056	0 608 720 040
	Reduction	19.3	58.6
	Avg. efficiency	0.93	0.9
	Installation length	mm 82.9	105.5
	Weight	kg 0.7	1.1
6 Transverse gearbox	Code	4ULG	
	Order no.	0 608 810 038	The transverse gearbox shortens the length of your tightening spindle by the installation length of the EC motor plus the installation length of the transverse gearbox.
	Reduction	1	The use of a transverse gearbox decreases the tightening spindle working area.
	Avg. efficiency	0.95	
	Installation length	mm 41.3	
	Weight [kg]	kg 1.4	
7 EC motor	Code	EC304	
	Order no.	0 608 701 018	
	Installation length	mm 247	
	Weight	kg 2.7	

Side-by-side arrangement of tightening spindles (center-to-center distance)

Number of tightening spindles	2	3	4	5	6
					
Min. circle diameter- \varnothing d_{\min} mm	4S51	56	65	79	95

Tightening spindles size 5 Spindle bearing



- ▶ Working range 5–500 Nm
- ▶ Max. output drive speed 515 rpm

Depending on the size, the actual components may differ from those in the illustration.

Features

- ▶ Various lengths with axial compensator
- ▶ Standard tool mounts
- ▶ Maximum efficiency
- ▶ Easy assembly due to flange connection
- ▶ Maintenance-free for 1 million full-load cycles

Tightening spindle		Spindle bearing				Measurement transducer	Planetary gearbox	EC motor
Working range *	Max. output drive speed	Range of spring mm /	Tool mount	Code	Order no.	Code / Order no.	Code / Order no.	Code / Order no.
Nm	rpm	Max. spring force N						
50–150	515	80 / 155	3/4" square with centering pin	GK3C281	0 608 800 079	5DMC530 0608 820 116	5GE19 0608 720 058	EC305 0608 701 019
				GK3C350	0 608 800 081			
				GL3C418	0 608 800 084			
50–500	145	80 / 155	3/4" square with centering pin	GK3C281	0 608 800 079	5DMC530 0608 820 116	5GE68 0608 720 041	EC305 0608 701 019
				GK3C350	0 608 800 081			
				GL3C418	0 608 800 084			





* Accuracy is limited if operating below the working range.

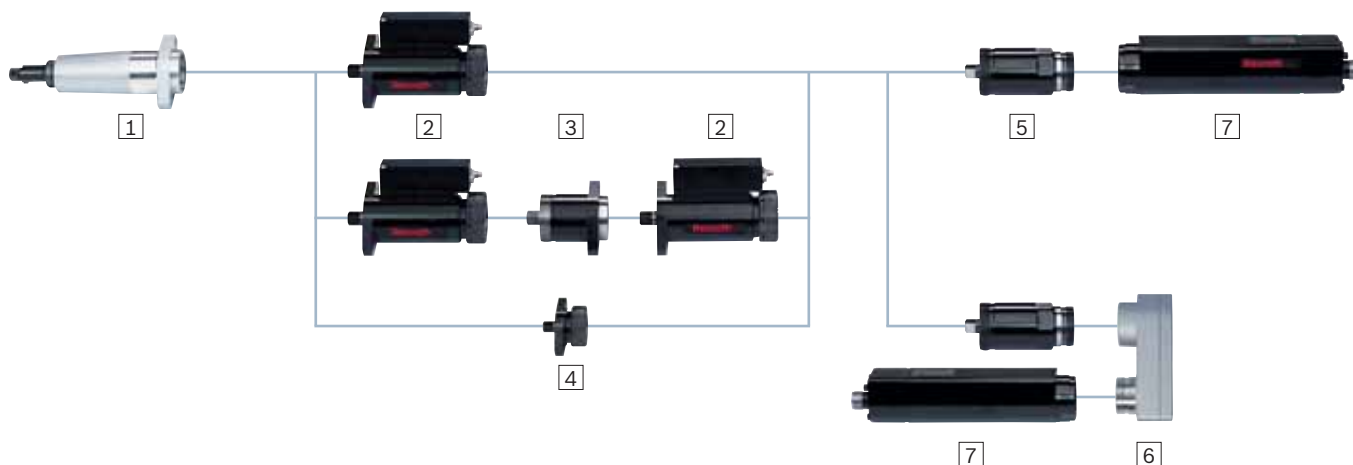

Note: You can find component dimensions and 3D/CAD data on the Internet at www.boschrexroth.com/tightening





Spindle bearing size 5

Components



1 Spindle bearing	Code	GK3C281	GK3C350	GL3C418
	Order no.	0608800079	0608800081	0608800084
	Max. torque	Nm 500	500	500
	Range of spring	mm 80	80	80
	Reduction	1	1	1
	Avg. efficiency	1	1	1
	Length A	mm 284	353	421
	Installation length	mm 302	371	439
	Weight	kg 3	3.5	4.5
2 Measurement transducer	Code	5DMC530		
	Order no.	0608820116		
	Nominal torque	530 Nm		
	Reduction	1		
	Avg. efficiency	1		
	Installation length	mm 125.5 mm		
	Weight	kg 3.7 kg		
3 Redundant adapter	Code	5AR		
	Order no.	0608810023		
	Reduction	1		
	Avg. efficiency	1		
	Installation length	mm 108		
	Weight	kg 2.4		
4 Adapter	Code	5A		
	Order no.	0608810027		
	Reduction	1		
	Avg. efficiency	1		
	Installation length	mm 48.5		
	Weight	kg 2.2		

5 Planetary gearbox 	Code	5GE19	5GE68
	Order no.	0608720058	0608720041
	Reduction	19.3	67.9
	Avg. efficiency	0.93	0.9
	Installation length	mm 154	188
	Weight	kg 2.9	3.7
6 Transverse gearbox 	Code	5ULG	
	Order no.	0608810039	
	Reduction	1	
	Avg. efficiency	0.95	
	Installation length	mm 63.8	The transverse gearbox shortens the length of your tightening spindle by the installation length of the EC motor plus the installation length of the transverse gearbox. The use of a transverse gearbox decreases the tightening spindle working area.
	Weight [kg]	kg 3.2	
7 EC motor 	Code	EC305	
	Order no.	0608701019	
	Installation length	mm 304	
	Weight	kg 6.4	

Side-by-side arrangement of tightening spindles (center-to-center distance)						
Number of tightening spindles		2	3	4	5	6
						
Min. circle diameter- $\varnothing d_{\min}$ mm	G...	86	100	131	162	172

Tightening spindles size 5 Offset output drive



- ▶ Working range 50–1000 Nm
- ▶ Max. output drive speed 515 rpm

Depending on the size, the actual components may differ from those in the illustration.

Features

- ▶ For tight hole templates
- ▶ Standard tool mounts
- ▶ Easy assembly due to flange connection
- ▶ Maintenance-free for 1 million full-load cycles

Tightening spindle		Offset output drive				Measurement transducer	Planetary gearbox	EC motor
Working range *	Max. output drive speed rpm	Range of spring mm	Tool mount	Code	Order no.	Code/ Order no.	Code/ Order no.	Code/ Order no.
Nm								
50-135	515	80	3/4" square with centering pin	VNK3C281	0 608 800 543	5DMC530 0608 820 116	5GE19 0608 720 058	EC305 0608 701 019
				VNK3C350	0 608 800 545			
				VNL3C418	0 608 800 548			
115-335	200	80	1" square with centering pin	VUK3D316	0 608 PE0 017	5DMC530 0608 820 116		EC305 0608 701 019
				VUK3D384	0 608 PE0 180			
50-465	145	80	3/4" square with centering pin	VNK3C281	0 608 800 543	5DMC530 0608 820 116	5GE68 0608 720 041	EC305 0608 701 019
				VNK3C350	0 608 800 545			
				VNL3C418	0 608 800 548			
115-1000	55	80	1" square with centering pin	VUK3D316	0 608 PE0 017	5DMC530 0608 820 116	5GE68 0608 720 041	EC305 0608 701 019
				VUK3D384	0 608 PE0 180			





* Accuracy is limited if operating below the working range.

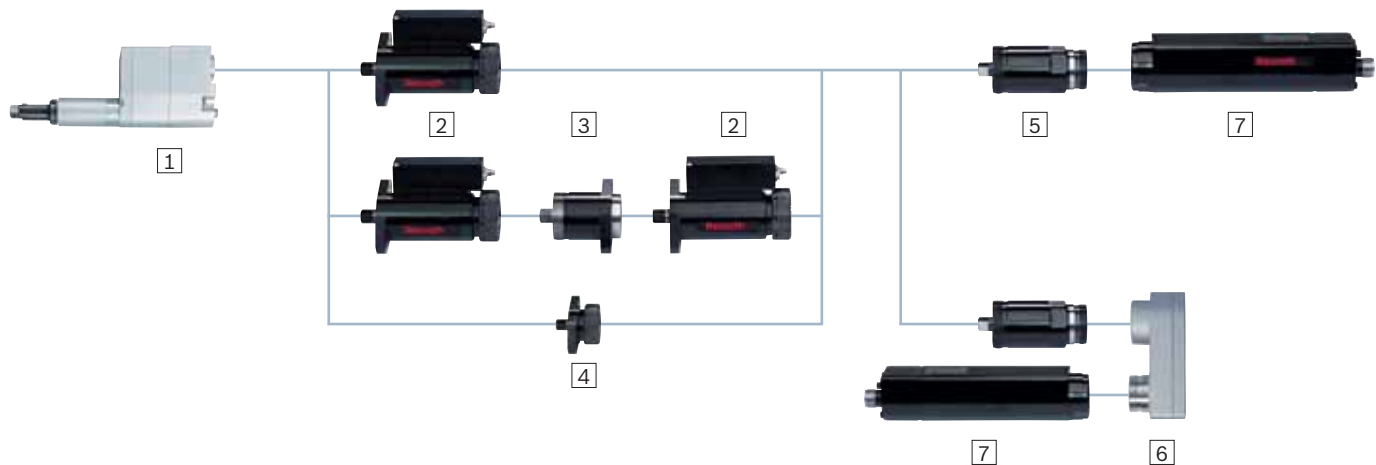

Note: You can find component dimensions and 3D/CAD data on the Internet at www.boschrexroth.com/tightening

Offset output drive size 5





Components



1 Offset output drive	Code	VNK3C281	VNK3C350	VNL3C418	VUK3D316	VUK3D384
	Order no.	0608800543	0608800545	0608800548	0608PE0017	0608PE0180
	Max. torque	Nm 500	500	500	1000	1000
	Range of spring	mm 80	80	80	80	80
	Reduction	1	1	1	2.51	2.51
	Avg. efficiency	0.92	0.92	0.92	0.9	0.9
	Length A	mm 284	353	421	320	388
	Installation length	mm 482	551	619	572	640
	Weight	kg 11.7	11.7	12.9	30	32
2 Measurement transducer	Code	5DMC530				
	Order no.	0608820116			You can configure your tightening spindle with a redundant measurement transducer from the same type.	
	Nominal torque	Nm 530	Connect both measurement transducers with the adapter. For measurement transducer cables, see page 126.			
	Reduction	1				
	Avg. efficiency	1				
	Installation length	mm 125.5				
	Weight	kg 3.7				
3 Redundant adapter	Code	5AR				
	Order no.	0608810023			When configuring with a redundant measurement transducer, the adapter connects both measurement transducers.	
	Reduction	1				
	Avg. efficiency	1				
	Installation length	mm 108				
	Weight	kg 2.4				
4 Adapter	Code	5A				
	Order no.	0608810027			When configuring without a measurement transducer, the adapter connects the output drive and the planetary gearbox.	
	Reduction	1				
	Avg. efficiency	1				
	Installation length	mm 48.5				
	Weight	kg 2.2				

5 Planetary gearbox	Code	5GE19	5GE68
	Order no.	0608720058	0608720041
	Reduction	19.3	67.9
	Avg. efficiency	0.93	0.9
	Installation length mm	154	188
	Weight kg	2.9	3.7
6 Transverse gearbox	Code	5ULG	
	Order no.	0608810039	
	Reduction	1	
	Avg. efficiency	0.95	
	Installation length mm	63.8	
	Weight [kg] kg	3.2	
		The transverse gearbox shortens the length of your tightening spindle by the installation length of the EC motor plus the installation length of the transverse gearbox. The use of a transverse gearbox decreases the tightening spindle working area.	
7 EC motor	Code	EC305	
	Order no.	0608701019	
	Installation length mm	304	
	Weight kg	6.4	

Side-by-side arrangement of tightening spindles (center-to-center distance)

Number of tightening spindles		2	3	4	5	6
						
Min. circle diameter- $\varnothing d_{\min}$	VN...	61	71	87	104	122
mm	VU...	94	108	133	159	187

Accessories for tightening spindles



Angle heads for size 5 tightening spindles

On request



Supports

On request



Angle heads with counter bracket

On request



Block output drives

On request

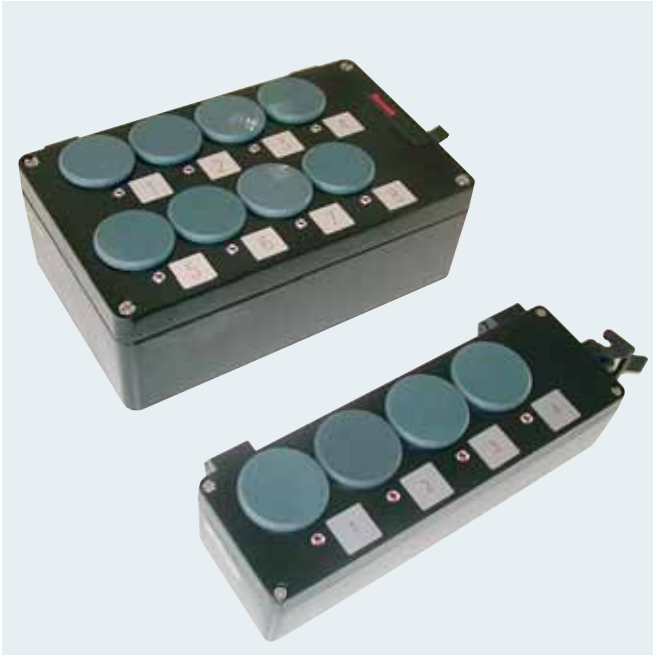

Socket trays

On request



Feed grippers

On request

NOTE:

For other application options and held-held tightening systems, see “Customized solutions” from page 136.

Ergonomic, powerful, handy

The ErgoSpin is designed according to the latest findings in ergonomics and fits the user's hand like a glove. The ergonomics of the handle, its light weight, and the optimum arrangement of operating and display elements increase worker productivity.



- ▶ Fast commissioning
- ▶ Flexible stock-keeping: only 1 cable type for all variants
- ▶ Maximum precision thanks to digital data transfer
- ▶ Ergonomic handling due to integrated, mechanical interface for reaction torque supports
- ▶ Process reliability thanks to clearly arranged display elements
- ▶ CC-ErgoSpin variant for function-critical tightening jobs

**ESM**

Pistolgrip nutrunner with integrated powerful LED for tightening position illumination

**Gripline**

Right-angle nutrunner with plastic-covered angle head for protection against scratches and accidental contacts as well as a second grip

**SlimLine**

Right-angle nutrunner with slim angle head for high accessibility.

**Varioline**

Zero-play spur gearing for free connection of crowfoot wrenches and special output drives

Hand-held nutrunner ESM ErgoSpin pistolgrip nutrunner for safety-critical tightening jobs



- ▶ With square tool mount, quick-change chuck, or 3/8" square tool mount
- ▶ Working range 2.4–35 Nm
- ▶ Max. output drive speed 1700 rpm
- ▶ Suitable for safety-critical tightening jobs in accordance with VDI/VDE 2862

Features

- ▶ Pistolgrip nutrunner, also suitable for hard-to-reach tightening positions
- ▶ With integrated powerful LED
- ▶ Standard tool mounts
- ▶ Tested for one million cycles under full load without maintenance



ESM with square tool mount

- ▶ Working range 2.4–35 Nm
- ▶ Max. output drive speed 1700 rpm

Working range	Max. output drive speed	Tool mount	Weight	Installation length	Code	Order no.
Nm	rpm		kg	mm		
2.4–12	1090	1/4" square	1	190	ESM012SD	0608841042
5–25	1700	3/8" square	1.4	223	ESM025SD	0608841044
7–35	1025	3/8" square	1.4	223	ESM035SD	0608841046



ESM with quick-change chuck tool mount

- ▶ Working range 2.4–12 Nm
- ▶ Max. output drive speed 1090 rpm

Working range	Max. output drive speed	Tool mount	Weight	Installation length	Code	Order no.
Nm	rpm		kg	mm		
2.4–12	1090	1/4" quick-change chuck	1	201	ESM012QD	0608841043



ESM with 3/8" square tool mount

- ▶ Working range 5–25 Nm
- ▶ Max. output drive speed 1700 rpm

Working range	Max. output drive speed	Tool mount	Weight	Installation length	Code	Order no.
Nm	rpm		kg	mm		
5–25	1700	3/8" square and zero-play spur gearing for free connection of special output drives	1.4	223	ESM025HT	0608841045

Note: For special output drives and planetary gearboxes suitable for the ErgoSpin, see "Accessories for ErgoSpin hand-held nutrunners" from page 86 onwards.

Hand-held nutrunner ErgoSpin GripLine for safety-critical tightening jobs



- ▶ Working range 1–75 Nm
- ▶ Max. output drive speed 1000 rpm
- ▶ Suitable for safety-critical tightening jobs in accordance with VDI/VDE 2862

Features

- ▶ Standard tool mounts
- ▶ Tested for one million cycles under full load without maintenance

Working range Nm	Max. output drive speed rpm	Tool mount	Weight kg	Installation length mm	Code	Order no.
1–5	1000	1/4" square	1.3	385	ESA005G	0608841028
2.6–13	1000	1/4" square	1.3	385	ESA013G	0608841029
6–30	800	3/8" square	1.6	423.5	ESA030G	0608841030
8–40	1000	3/8" square	1.8	437	ESA040G	0608841031
11–56	710	3/8" square	1.9	453	ESA056G	0608841032
13–65	610	1/2" square	1.9	453	ESA065G	0608841033
15–75	530	1/2" square	2.1	454	ESA075G	0608841034

Hand-held nutrunner ErgoSpin SlimLine for safety-critical tightening jobs



- ▶ Working range 1–220 Nm
- ▶ Max. output drive speed 1000 rpm
- ▶ Suitable for safety-critical tightening jobs in accordance with VDI/VDE 2862

Features

- ▶ Angle head has a non-interchangeable code and can be turned and locked in 15-degree steps
- ▶ Integrated LEDs visible all around
- ▶ Tested for one million cycles under full load without maintenance

Working range Nm	Max. output drive speed rpm	Tool mount	Weight kg	Installation length mm	Code	Order no.
1–5	1000	1/4" square	1.3	382	ESA005S	0608841018
2.6–13	1000	1/4" square	1.3	382	ESA013S	0608841019
6–30	800	3/8" square	1.6	416	ESA030S	0608841020
8–40	1000	3/8" square	1.7	434	ESA040S	0608841021
11–56	710	3/8" square	1.9	446	ESA056S	0608841022
13–65	610	1/2" square	1.9	448	ESA065S	0608841023
15–75	530	1/2" square	2	450	ESA075S	0608841024
20–100	630	1/2" square	3.1	492	ESA100S	0608841025
30–150	380	1/2" square	3.8	531	ESA150S	0608841026
44–220	260	3/4" square	4	541	ESA220S	0608841027

Hand-held nutrunner ErgoSpin VarioLine for safety-critical tightening jobs



- ▶ Working range 1 – 146 Nm
- ▶ Max. output drive speed 1700 rpm
- ▶ Suitable for safety-critical tightening jobs in accordance with VDI/VDE 2862

Features

- ▶ Extended application options in combination with handling devices and special output drives (e.g. crowfoot wrenches)
- ▶ Can be used as a tightening spindle with output drive adapters
- ▶ Fully suitable for robot use
- ▶ Tested for one million cycles under full load without maintenance

Working range Nm	Max. output drive speed rpm	Tool mount	Weight kg	Installation length mm	Code	Order no.
1–5	1090	Standard machine without	1.1	333	ESV005	0 608 841 041
2.4–12	1090	output drive, with zero-play	1.1	333	ESV012	0 608 841 035
5–25	1700	spur gearing for free	1.4	365	ESV025	0 608 841 037
10–50	830	connection of crowfoot	1.5	375	ESV050	0 608 841 038
14–73	900	wrenches and special	2.4	406	ESV073	0 608 841 039
29–146	420	output drives	2.8	430	ESV146	0 608 841 040

Hand-held nutrunner

ESM CC-ErgoSpin pistolgrip nutrunner for function-critical tightening jobs



- ▶ Working range 2.4–12 Nm
- ▶ Max. output drive speed 1090 rpm
- ▶ Suitable for function-critical tightening jobs in accordance with VDI/VDE 2862

Features

- ▶ With integrated powerful LED
- ▶ Standard tool mounts
- ▶ Tested for one million cycles under full load without maintenance

Working range Nm	Max. output drive speed rpm	Tool mount	Weight kg	Installation length mm	Code	Order no.
2.4–12	1090	1/4" quick-change chuck	1	201	CC-ESM012QD	0608841089

Note: For special output drives and planetary gearboxes suitable for the ErgoSpin, see "Accessories for ErgoSpin hand-held nutrunners" from page 86 onwards.

Hand-held nutrunner CC-ErgoSpin SlimLine for function-critical tightening Jobs



- ▶ Working range 6–40 Nm
- ▶ Max. output drive speed 1000 rpm
- ▶ Suitable for function-critical tightening jobs in accordance with VDI/VDE 2862

Features

- ▶ Angle head has a non-interchangeable code and can be turned and locked in 15-degree steps
- ▶ Integrated LEDs visible all around
- ▶ Tested for one million cycles under full load without maintenance

Working range Nm	Max. output drive speed rpm	Tool mount	Weight kg	Installation length mm	Code	Order no.
6–30	800	3/8" square	1.6	416	CC-ESA030S	0608841087
8–40	1000	3/8" square	1.7	434	CC-ESA040S	0608841088

Hand-held nutrunner CC-ErgoSpin VarioLine for function-critical tightening Jobs



- ▶ Working range 2.4–12 Nm
- ▶ Max. output drive speed 1090 rpm
- ▶ Suitable for function-critical tightening jobs in accordance with VDI/VDE 2862

Features

- ▶ Extended application options in combination with handling devices and special output drives
- ▶ Can be used as a tightening spindle with output drive adapters
- ▶ Fully suitable for robot use
- ▶ Tested for one million cycles under full load without maintenance

Working range Nm	Max. output drive speed rpm	Tool mount	Weight kg	Installation length mm	Code	Order no.
2.4–12	1090	Standard machine without output drive, with zero-play spur gearing for free connection of crowfoot wrenches and special output drives	1.1	333	CC-ESV012	0608 841 090

Output drives for ErgoSpin/CC-ErgoSpin VarioLine

VarioLine hand-held nutrunner becomes a tightening spindle

- ▶ Extended application options in combination with handling devices

- ▶ Can be used as a tightening spindle with output drive adapters
- ▶ Fully suitable for robot use

Angle heads

You can mount different angle heads on the ErgoSpin VarioLine. This makes your ErgoSpin hand-held nutrunner suitable for a variety of applications.

With an angle head for special output drives, you can e.g. mount a crowfoot wrench to the VarioLine.

VarioLine combination options with angle heads



ErgoSpin VarioLine Code	Code	Tool mount	Max. torque** Nm	Reduction	Avg. efficiency	Order no.
ESV005/ CC-ESV005	WH013S	1/4" square	13	1.1	0.95	3608876051
	WH013G*	1/4" square	13	1.1	0.95	3608876052
ESV012/ CC-ESV012	WH013S	1/4" square	13	1.1	0.95	3608876051
	WH013G*	1/4" square	13	1.1	0.95	3608876052
ESV025	WH040S	3/8" square	40	1.73	0.95	3608876055
	WH040G*	3/8" square	40	1.73	0.95	3608876056
ESV050	WH056S	3/8" square	56	1.16	0.95	3608876057
	WH056G*	3/8" square	56	1.16	0.95	3608876058
	WH065S	1/2" square	65	1.35	0.95	3608876059
	WH065G*	1/2" square	65	1.35	0.95	3608876060
	WH075S	1/2" square	75	1.56	0.95	3608876061
	WH075G*	1/2" square	75	1.56	0.95	3608876062
ESV073	WH100S	1/2" square	100	1.42	0.95	3608876063
ESV146	WH150S	1/2" square	150	1.1	0.95	3608876064
	WH220S	3/4" square	220	1.59	0.95	3608876065



ErgoSpin VarioLine Code	Code	Tool mount	Max. torque** Nm	Reduction	Avg. efficiency	Order no.
ESV025	WHS040	3/8" square	40	1.73	0.95	3608876081
ESV050	WHS075	1/2" square	75	1.56	0.95	3608876082
ESV073	WHS100	1/2" square	100	1.42	0.95	3608876083

* Plastic-covered titanium angle head as a second grip

** Value refers to angle head

Straight output drives

Straight output drives combined with the ErgoSpin VarioLine produce a straight nutrunner. The combination of VarioLine and straight output drives always delivers

an ergonomic solution for tightening cases of up to 12 Nm: whether vertically suspended, as a hand-held straight nutrunner, a hand-held application, or in connection with handling devices.

VarioLine combination options with straight output drives*



ErgoSpin VarioLine Code	Working range Nm	Tool mount	Reduction	Avg. efficiency	Installation length mm	Weight kg	Code	Order no.
ESV005	1–5	1/4" square	1	1	31.5	0.1	ESISA012	0608810047
	1–5	1/4" quick-change chuck	1	1	31.5	0.1	ESIQA012	0608810048
ESV012/ CC-ESV012	2.4–12	1/4" square	1	1	31.5	0.1	ESISA012	0608810047
	2.4–12	1/4" quick-change chuck	1	1	31.5	0.1	ESIQA012	0608810048

Output drive adapters

With the output drive adapters, you can combine the ErgoSpin VarioLine with output drives in sizes 2, 3, and 4

for tightening spindles and e.g. use it as a tightening spindle.

VarioLine combination options with output drive adapters*



ErgoSpin VarioLine Code	Working range Nm	Tool mount	Reduction	Avg. efficiency	Installation length mm	Weight kg	Code	Order no.
ESV005	1–5	Size 2	1	1	41.4	0.1	ESOA012	0608810 049
ESV012/ CC-ESV012	2.4–12	Size 2	1	1	41.4	0.1	ESOA012	0608810049
ESV025	5–25	Size 3	1	1	40.3	0.1	ESOA025	0608810050
ESV050	10–50	Size 3	1	1	41.2	0.2	ESOA050	0608810051
ESV073	14–73	Size 4	1	1	44.5	0.3	ESOA073	0608810052
ESV146	29–146	Size 4	1	1	44	0.3	ESOA146	0608810053

* Special output drives on request

Accessories for ErgoSpin / CC-ErgoSpin hand-held nutrunners

**Holder for right-angle nutrunner and straight nutrunner**

Code	Order no.
ESAT	3608876626

**Holder for ESM pistolgrip nutrunner**

Code	Order no.
ESMT	3608877433

**Turning suspension**

Code	Ø mm	ErgoSpin	Order no.	Weight g
ESMH1	50	ESA005-075	3608875426	100
		ESV005-050		
ESMH2	63	ESA100-220	3608875921	145
		ESV073-146		

Turning suspension for ErgoSpin with extension

On request

**Suspension for ErgoSpin pistolgrip nutrunner**

Code	Order no.
ESMB	3608876767



Extension

Code	Installation length mm	ErgoSpin	Order no.
ESET040	200	ESA040	3 608 877 798
ESET056	250	ESA056	3 608 877 799
ESET065	250	ESA065	3 608 877 800
ESET075	250	ESA075	3 608 877 801
ESET100	250	ESA100	3 608 877 802



Extra grip

Code	ErgoSpin	Order no.
ESMH12	ESM012SD, ESM012QD	3 608 877 111
ESMH25	ESM025SD, ESM025HT, ESM035SD	3 608 877 112

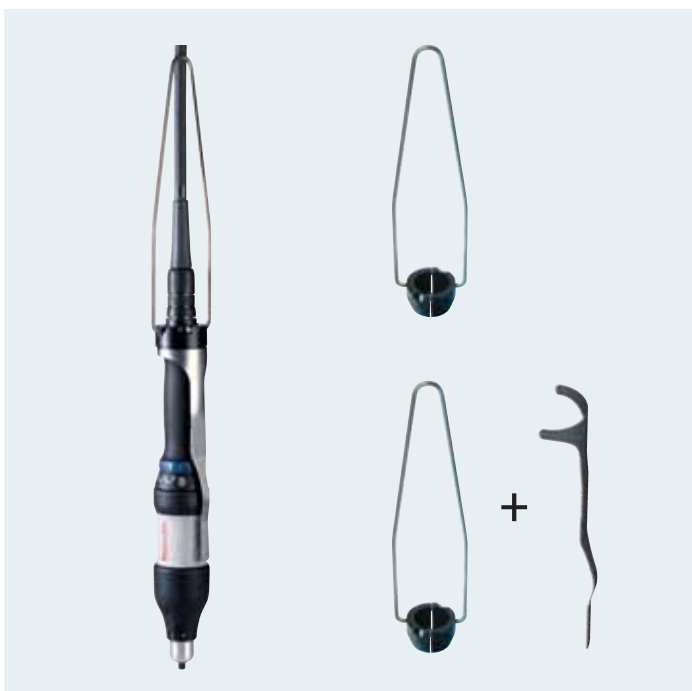

Vertical suspension

Code	ErgoSpin	Order no.	Weight g
ESMV	ESA005-075 ESV005-050	ESA005-075	180

Start lever extension for straight nutrunners incl. vertical suspension

Code	ErgoSpin	Order no.	Weight g
ESTE	ESA005-075 ESV005-050	3 608 876 175	235

Accessories for ErgoSpin/CC-ErgoSpin hand-held nutrunners

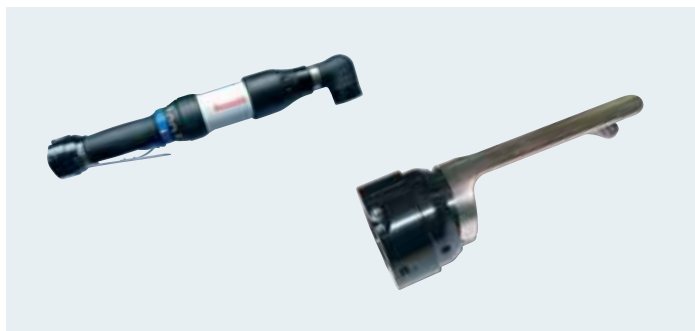

Stroke extension

Code	Order no.
ESSE	3608876746

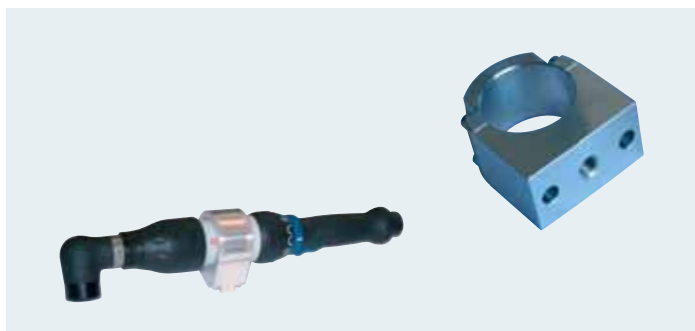

Adapter for handling devices from Bosch Rexroth

Code	ErgoSpin	Order no.
ESCU1B	ESA005-075, ESV005-050	3608876459
ESCU2B	ESA100-220, ESV073-146	3608876409



Adapter for handling devices from Bosch Rexroth

Code	ErgoSpin	Order no.
ESCU1F	ESA005-075, ESV005-050	3608876751
ESCU2F	ESA100-220, ESV073-146	3608876749



Torque support

On request



Socket tray

On request



ErgoSpin with integrated scanner

On request



**Planetary gearboxes for high torques
up to 100, 340, and 600 Nm**

On request

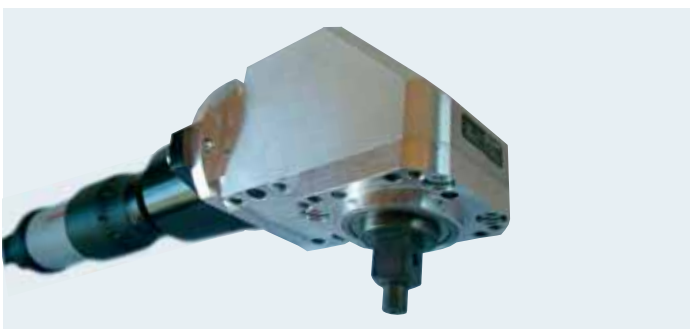

Angle heads for torques from 220 Nm

On request

Nexo – intelligent cordless nutrunners

Rexroth intelligent cordless nutrunners join wireless technology with all the advantages of the proven ErgoSpin hand-held nutrunner for all category A safety-critical tightening jobs in accordance with VDI2862: results logging, output, and documentation.



- ▶ Fits into the existing infrastructure of any production environment
- ▶ Integrated control and power electronics eliminates necessity for multiple connected components
- ▶ An additional controller is no longer needed thanks to a direct Wi-Fi connection between nutrunner and access point.

Nexo cordless nutrunner NXP pistolgrip nutrunner



- ▶ Working range 3.6 – 12 Nm
- ▶ Max. output drive speed 750 rpm

Features

- ▶ For troublefree working at hard-to-reach tightening positions
- ▶ Ergonomic design and maximum freedom of movement
- ▶ Graphic display: direct and clear display of the tightening quality
- ▶ Reliable availability of information regardless of position and wireless connection
- ▶ Quick parameterization on site

Working range Nm	Max. output drive speed rpm	Tool mount	Weight kg	Installation length mm	Code	Order no.
3.6–12	750	1/4" quick-change chuck	1.35	295	NXP012QD-36V	0608842005

Nexo cordless nutrunner

NXA right-angle nutrunner



- ▶ Working range 9.0–30 Nm
- ▶ Max. output drive speed 310 rpm

Features

- ▶ With slim angle head for high accessibility
- ▶ Graphic display: direct and clear display of the tightening quality
- ▶ Reliable availability of information regardless of position and wireless connection
- ▶ Quick parameterization on site

Working range Nm	Max. output drive speed rpm	Tool mount	Weight kg	Installation length mm	Code	Order no.
9–30	310	3/8" square	2.07	605	NXA030-36V	0 608 842 002

Nexo – Accessories and extensions



Simple charger

Code	Order no.
NX-BC36V	0608 843 002



Slide-in battery pack

Code	Order no.
NX-BP36V	0608 843 001



Assorted colored rings

Code	Order no.
NX-R	0608 843 010



MicroSD card

Code	Order no.
NX-R	0608 843 005

Nexo – accessories and extensions



Holder for right-angle nutrunners

Code	Order no.
ESAT	3 608 876 626



Holder for pistolgrip nutrunners

Code	Order no.
NXPT	0 608 843 008



Turning suspension for right-angle nutrunners

Code	Order no.
NXAMT	0 608 843 003



Suspension for pistolgrip nutrunners

Code	Order no.
NXPB	0 608 843 004



Extra grip for pistolgrip nutrunners

Code	Order no.
NXPH	0608 843 009

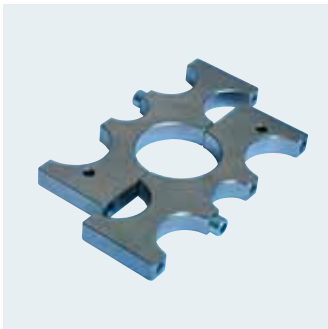

Mounting aid for angle heads

Code	Order no.
ESMW	3608876473



Programming adapter

Code	Order no.
NX-A	0608 843 006



Access point

Code	Order no.
NX-ACCESS	0608843007

Control and power electronics

The hardware platform is based on cutting-edge technology and thus ensures investment security. It has been specially developed for industrial applications. The system box and compact system fully comply with the IP54 protection class.



- ▶ Modular design, ideal adjustment to the tightening case
- ▶ Maintenance-free for 1 million full-load cycles, long service life
- ▶ Process reliability and minimal waste thanks to real redundancy measurement, digital measurement transfer, maximum precision

Maximum flexibility in tightening spindle configuration – here are just some of the many options

One nutrunner – multiple nutrunners?

1 Compact system or modular system

1 tightening channel = CS351 Compact System

p. 98

2 to 40 tightening channels = 350 modular system

p. 104

350 modular system – where to store the system components?

2 BT card rack or SB system box

The card rack is designed for installation in a control cabinet.

Tightening systems without control cabinets are possible with the system box.

Universal communication – the KE communication unit

3 Configuration of the first BT card rack/first SB system box

VM power supply module

KE communication unit

SE control units

Max. 3 SE per BT/SP

LTS/LTE servo amplifiers (tightening spindle/ErgoSpin respectively)

Max. 5 LTS/LTE per BT/SB

1, 2, 3... and many more

4 Connecting multiple BT card racks/SB system boxes

Multiple BT/SB are connected to NK network couplers.

No KE is required from the 2nd BT/SB upwards.

Another LTS/LTE can be inserted in its position.

Configuration from 2nd BT/SB:

Max. 3 SE per BT/SP

Max. 6 LTS/LTE per BT/SB

CS351 Compact System

The operating and display units, as well as the connections, are arranged in a user-friendly, modern, and convincing design. The clear structure of the CS351 allows intuitive operation without any complicated configuration. The housing, which is no larger than a minitower, fully complies with protection class IP54. Its compact interior combines power electronics and Ethernet-based bus systems with the new high-performance 350 control generation.

- TFT with touchscreen
(or display)**
- Abrasion-resistant ID plate**
- Status display via LEDs**
- Easy-to-access
USB programming interface**





- ▶ Compact and powerful
- ▶ Clear system design
- ▶ Secure and fast commissioning
- ▶ Tightening results at a glance
- ▶ Clearly arranged control and display elements
- ▶ Sturdy: IP54, EMC severity level IV
- ▶ USB and Ethernet-based bus systems
- ▶ Flexible adaptation to new tasks



CS351 Compact System model variants



Compact System CS351...-G...

High-quality TFT with touch screen and large viewing angle

- ▶ Resolution: 640x480
- ▶ Actual value display
- ▶ Tightening graph display
- ▶ Parameter changes
- ▶ Ethernet on board
- ▶ Tightening program selection

Compact System CS351...-D...

Display version with DVI interface

- ▶ Actual value display
- ▶ Connection to external DVI monitor and input unit
- ▶ Ethernet on board

Compact System for	Code	Weight kg	Order no.
ErgoSpin	CS351E-G	9.7	0 608 830 258
	CS351E-D	9.5	0 608 830 257
	CS351E-G IL	9.7	0 608 830 275
	CS351E-D IL	9.5	0 608 830 274
	CS351E-D NK	9.9	0 608 830 281
Tightening spindle	CS351S-G	9.7	0 608 830 255
	CS351S-D	9.5	0 608 830 254
	CS351S-G IL	9.7	0 608 830 277
	CS351S-D IL	9.5	0 608 830 276
	CS351S-D NK	9.9	0 608 830 282

Note: For cable selection, see "Rexroth cables" from page 122.

CS351

- ▶ Dimensions (HxWxD): 358x210x253 mm
- ▶ Very easy suspension, even in tight areas
- ▶ Hinged, removable interface cover
- ▶ Highly flexible and future-proof due to interface modules
- ▶ IP54 protection class
- ▶ 120 V and 230 V power supply
- ▶ Mains connection cable for 230 V included in the scope of delivery
- ▶ Motor stop interface
- ▶ RCD
- ▶ Exchange connection cable – without tools

The speed of BG 4/5 motors is 15% lower in conjunction with compact controllers than in conjunction with modular controllers.

The torque of the BG 5 motors is 30% lower in conjunction with compact controllers than in conjunction with modular controllers.

CS351... IL

- ▶ Integrated logic
- ▶ Flexible programming according to IEC 61131-3
- ▶ Easy automation for the entire tightening process

CS351...NK

- ▶ Can be connected as an additional tightening channel to the KE350/KE350G IL via the network coupler cable
- ▶ Complete system bus diagnosis
- ▶ Central data output via the KE350/KE350G IL

CC-CS351 Compact System for CC-ErgoSpin



- ▶ For CC-ErgoSpin hand-held nutrunner control
- ▶ Use in function-critical tightening jobs

Features

- ▶ Secure and fast commissioning
- ▶ Tightening results at a glance
- ▶ Sturdy: IP54, EMC severity level IV
- ▶ USB and Ethernet interface
- ▶ Clear system design
- ▶ Flexible adaptation to new tasks
- ▶ Clearly arranged control and display elements

Compact System for	Code	Weight kg	Order no.
CC ErgoSpin	CC-CS351E-D	9.5	0608841289

Slots and connections

To ensure that the tightening system optimally matches your control environment today and in the future, it features three slots for interface modules, which are covered with dummy panels at the factory.

The CS351E-D... and CS351S-D... Compact Systems have an additional DVI interface to connect an external monitor and a corresponding USB feedback channel.

To gain a better understanding of the slots, see “CS351 Compact System” from page 98.



- 1 Slot A for type A interface modules
- 2 USB host interface
(only for CS351S-D and CS351E-D)
- 3 Interface to connect
an external DVI monitor
(only for CS351S-D and CS351E-D)
- 4 Slot for CF350 mass storage
- 5 Ethernet
- 6 Serial interface
- 7 Two USB interfaces
- 8 Motor stop interface
- 9 Two slots (B1, B2)
for type B interface modules

Slot	Fieldbus/designation	Code	Order no.	Page
A	PROFIBUS DP	IMpdp	0 608 830 266	120
	DeviceNet	IMdev	0 608 830 267	120
	PROFINET IO	IMpnio	0 608 830 272	120
	EtherNet/IP	IMenip	0 608 830 271	121
	ModbusTCP	IMmtcp	0 608 830 273	121
B	24-V I/O interface	IM24V	0 608 830 259	121
X6C1	Mass storage	CF350	3 608 877 428	–
XDAC1 / XDAC2	Network coupler cable	NKL0.5	3 608 877 369	125/129
		NKL002	3 608 877 370	
		NKL005	3 608 877 371	
		NKL010	3 608 877 372	
		NKLF*	3 608 877 373 /...	

Note: For cable selection, see “Rexroth cables” from page 122.

Modular system



The SB356 system box and the BT356 card rack, made from durable stainless steel, are required in the modular system to support the control and power electronics.

Besides the VM350 power supply module, the BT/SB can also be equipped with up to six tightening channels. The tightening channels comprise an SE352 or SE352M control unit that controls up to two LTS350D servo amplifiers for tightening spindles or LTE350D servo amplifiers for ErgoSpin hand-held nutrunners. Mixed operation of tightening spindles and ErgoSpin on a SE352 or SE352M is possible at any time.

The KE350 or KE350G IL communication unit is responsible for internal and external system communication. It is inserted in the outermost BT/SB slot, instead of the sixth servo amplifier. When the KE350 or KE350G IL is inserted in the first SB or the

- ▶ Multi-channel tightening system
- ▶ Can be upgraded to up to 40 tightening channels
- ▶ Combination of tightening spindles/ErgoSpin
- ▶ Uncomplicated programming
- ▶ Either in card rack or system box
- ▶ Convenient installation thanks to modularity



The splash-proof SB356 system box is intended for operation without a control cabinet in an industrial environment.



The BT356 card rack is intended for installation in control cabinets.

first BT, up to 16 BT/SB can be connected via the NK350 or NK350S network coupler and NKL network coupler cables.

The flexibly programmable logic integrated in the KE350G IL is in compliance with IEC 61131-3 and gives the user countless automation options for the entire tightening process.

Unused slots must be closed off with dummy panels for safety reasons and for reasons of electromagnetic compatibility.

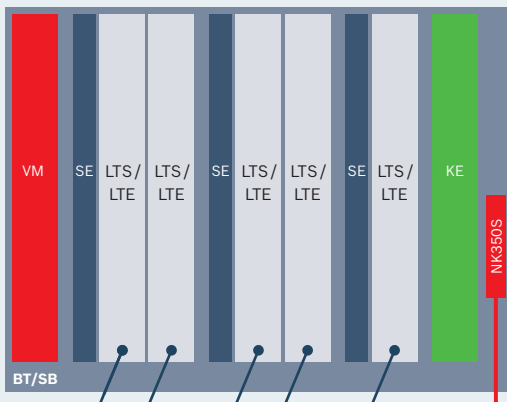

1 card rack/system box for up to 5 tightening channels and communication unit

- BT** Card rack
- SB** System box
- VM** Power supply module
- KE** Communication unit
- SE** Control unit
- LTS** Servo amplifier for tightening spindles
- LTE** Servo amplifier for ErgoSpin hand-held nutrunners
- NK** Network coupler

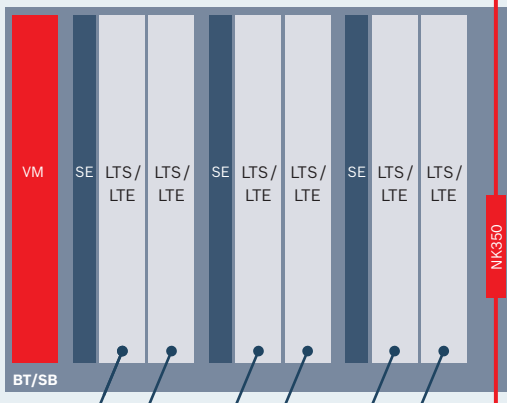

Combination of multiple card racks/system boxes for up to 40 tightening channels

Max. 6 tightening channels per BT/SB

Max. total length of all network coupling cables: 150 m

Maximum length of one network coupling cable: 50 m

Control of max. 40 tightening channels with one KE350 (up to 16 network couplers)

Point-to-point connection: defined physical conditions

Multi-colored LED on network coupler for network status display

Type and timing of the incoming signals are processed and supplied to the nearest NK350.

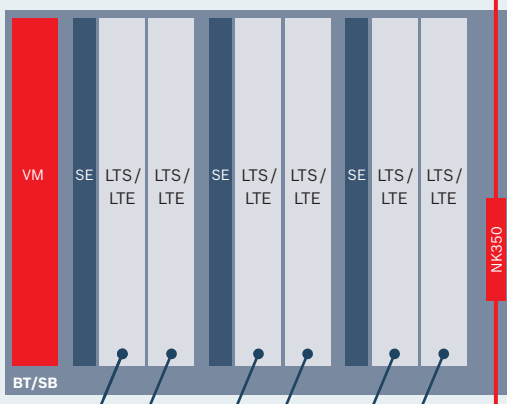

SB356 System Box



- ▶ To accommodate the control and power electronics for up to six tightening channels
- ▶ IP54 protection class

Features

- ▶ Designed for operation without control cabinet
- ▶ For networking of up to 16 BT/SB (with NK350 or NK350S network coupler and NKL network coupler cables)
- ▶ Compact dimensions
- ▶ High packing density
- ▶ Combination of hand-held nutrunner and stationary technology possible

Code	Dimensions W x H x D mm	Weight (empty) kg	Order no.
SB356	510x600x470	55	0608830251

SB356 system box configuration	Up to 5 channels, 1x SB356	Up to 40 channels, multiple SB356		Info on page
	SB 356 system box	First SB356 system box	Additional SB356 system boxes	
	Number of slots	Number of slots	Number of slots per SB356	
VM 350 power supply module	1	1	1	112
KE350 communication unit	1	1	–	115
SE352/SE352M control unit	3	3	3	113
LTS350D/LTE350D servo amplifier	5	5	6	114
Tightening channels	5	5	6	110/111
NK350S/NK350 network coupler	–	1x NK350S	1x NK350	116

Dummy panels

Empty slots are closed off with dummy panels.





Two versions are available:

BP351 closes off a KE or LT slot; BP352 simultaneously closes off an SE and an LT slot.



Code	Order no.
BP351	3608878058
BP352	3608878060

Non-standard locks for SB356

Code	Order no.
I1	3608874026
I16	3608874109
 3 mm	3608874027
 Fiat	3608874028
 Daimler	3608874029
 7 mm	3608874030

BT356 card rack



- ▶ To accommodate the control and power electronics for up to six tightening channels
- ▶ For assembly in the control cabinet or to the mounting plate using mounting brackets

Features

- ▶ For networking of up to 16 BT/SB (with NK350 or NK350S network coupler and NKL network coupler cables)
- ▶ Compact dimensions

Code	Dimensions W x H x D mm	Weight (empty) kg	Order no.
BT356	310x483x381	7	0608830253

BT356 system box configuration	Up to 5 channels, 1x BT356	Up to 40 channels, Multiple BT356		Info on page
	BT356 card rack	First BT356 card rack	Additional BT356 card racks	
	Number of slots	Number of slots	Number of slots per BT356	
VM 350 power supply module	1	1	1	112
KE350 communication unit	1	1	–	115
SE352/SE352M control unit	3	3	3	113
LTS350D/LTE350D servo amplifier	5	5	6	114
Tightening channels	5	5	6	110/111
NK350S/NK350 network coupler	–	1x NK350S	1x NK350	116

Permissible configuration with BT356/SB356 Servo amplifiers

Planning assistance: system box and card rack configuration

One tightening channel consists of the following components:

- ErgoSpin hand-held nutrunner or tightening spindle
- Connection cable
- Control unit
- Servo amplifier

The KE350 or KE350G IL communication unit is responsible for internal and external system communication. If the appropriate control and power electronics are installed, both stationary tightening spindles and ErgoSpin hand-held nutrunners can be connected to and operated on the SB356 system box and the BT356 card rack. Mixed operation of stationary tightening spindles and ErgoSpin hand-held nutrunners on a system box or a card rack is possible at any time.

Not every configuration is permitted due to the fact that the power consumption of the servo amplifier depends

on the type of tightening spindle or ErgoSpin hand-held nutrunner that is connected. The maximum permissible peak current for up to six tightening channels in the card rack or system box is 140A. This is why you may only install components with a power consumption that does not exceed a total of 140 A.

Total power consumption (tightening spindles + ErgoSpin) ≤ 140 A

- ▶ Up to 40 tightening channels by combining multiple card racks/system boxes
- ▶ Maximum system reliability thanks to 100% digital data transfer
- ▶ Integrated system for hand-held nutrunners and stationary technology
- ▶ Scalable and open for extensions

Power consumption Ampere	Stationary tightening spindles				ErgoSpin hand-held nutrunners			
	45 A	28 A	14 A	7 A	50 A	33 A	18 A	11 A
Tightening spindle or ErgoSpin hand-held nutrunner	LTS350D servo amplifier + Tightening spindle size 5	LTS350D servo amplifier + Tightening spindle size 4	LTS350D servo amplifier + Tightening spindle size 3	LTS350D servo amplifier + Tightening spindle size 2	LTE 350D servo amplifier + ErgoSpin hand-held nutrunners ESA100S ESA150S ESA220S ESV073 ESV146	LTE 350D servo amplifier + ErgoSpin hand-held nutrunners ESA040... ESA056... ESA065... ESA075... ESM025... ESM035... ESV025 ESV050	LTE 350D servo amplifier + ErgoSpin hand-held nutrunners ESA030...	LTE 350D servo amplifier + ErgoSpin hand-held nutrunners ESA013... ESM012QD ESV005 ESV012

Example: wheel bolts

In this example, five wheel bolts on each side of the vehicle are tightened to 130 Nm using size 4 tightening spindles.

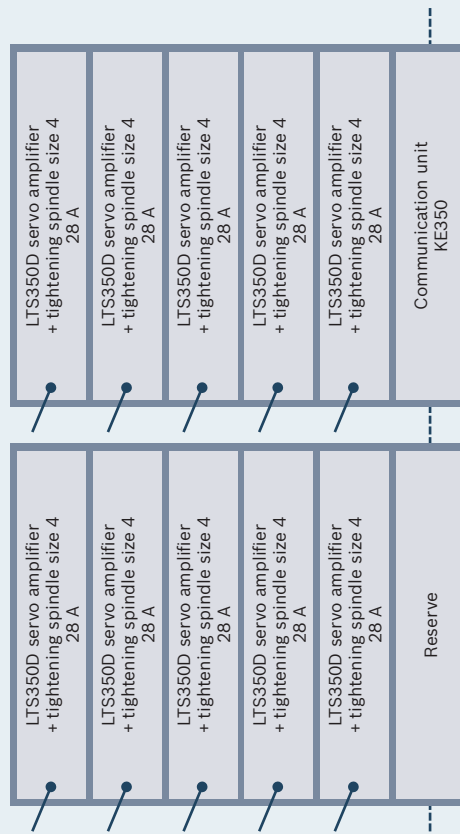
**Ethernet connection**

BT/SB power consumption
 $5 \times 28 \text{ A} = 140 \text{ A} (\leq 140 \text{ A})$

Up to 5 tightening spindles can be operated on the first system box/first card rack.

Networking with network coupler

System boxes and card racks can be connected using network couplers.

Example: motor connection

In this example, the camshaft bearing cap and the cylinder head are each tightened to the motor with double nutrunners (size 3 and 4 tightening spindles) with 15 Nm and 130 Nm respectively. In addition, small parts are tightened with right-angle and pistolgrip nutrunners.

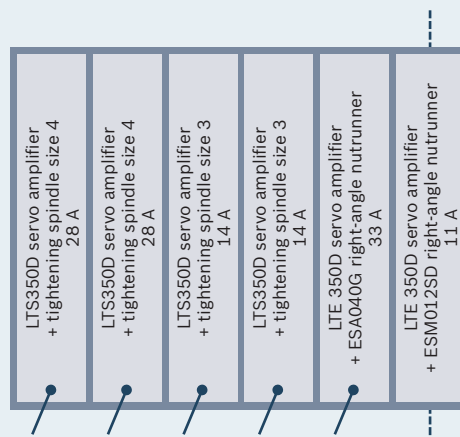
**Networking with network coupler**

BT/SB power consumption
 $2 \times 28 \text{ A} + 2 \times 14 \text{ A} + 33 \text{ A} + 11 \text{ A} = 128 \text{ A}$
 $(\leq 140 \text{ A})$

Mixed operation with up to six tightening channels is possible on an SB356 system box or a BT356 card rack.

VM350 power supply module



- ▶ Used to supply power to all the slots in the BT356 card rack or in the SB356 system box.

Code	Order no.
VM350	0 608 750 110

Features

- ▶ One VM350 is required for each card rack or system box.
- ▶ 24 V interface (X1S1) on the front to ensure external power supply of the KE, SE, and LT in event of power failure or if the supply is switched off
- ▶ Motor stop interface
- ▶ 24 V power supply for external consumers

SE352 and SE352M control units



- ▶ To control and monitor the tightening process of up to two independent tightening channels per control unit
- ▶ Use in multi-channel tightening systems requires a KE350/KE350G IL communication unit.

Code	Order no.
SE352	0 608 830 262
SE352M	0 608 830 263



Example layout
SE352M with IM24V

Features

- ▶ Carries out system diagnosis and monitors all individual components of a tightening channel
- ▶ Tightening processes and rework strategies are simply and flexibly programmed via the BS350 operating system.
- ▶ Automatic recognition of individual components enables fast and secure start-up.
- ▶ The SE352M control unit is equipped with one free slot (on delivery, the SE352M control unit slot is sealed with a cover). An IM24V interface module can be inserted in this slot for communication with superior controllers.

Servo amplifiers for tightening spindles and ErgoSpin/CC-ErgoSpin hand-held nutrunners



- ▶ For EC motor control
- ▶ Integrated motor contactor

Code		Order no.
LTS350D	For all tightening spindles	0 608 750 125
LTE350D	For all ErgoSpin/CC-ErgoSpin hand-held nutrunners	0 608 750 126

Features

- ▶ The control parameters are transmitted digitally from the SE control unit to the LT servo amplifier
- ▶ LC display for tightening results and system information

KE350 and KE350G IL communication units



- ▶ To coordinate individual control units and organize the interfaces with external systems (e.g. PLC or central computer)

Code	Order no.
KE350	0 608 830 264
KE350G IL	0 608 830 265

Features

- ▶ System-internal communication with the control units occurs via a standard bus system
- ▶ One serial interface and three free slots for connecting to external systems
- ▶ Various interface modules are available for controlling and data communication
- ▶ On delivery, the slots in the KE350 and KE350G IL communication units are closed off with covers
- ▶ Integrated logics in KE350G IL: flexible programming in compliance with IEC 61131 3, enables countless automation options for the entire tightening process

Accessories for control and power electronics



Network coupler

Code	Order no.
NK350	3 608 877 367
NK350S	3 608 877 368
	3 608 877 ...



Dummy panels

Code	Order no.
BP351	3 608 878 058
BP352	3 608 878 060



Mounting bracket set for BT356

Code	Order no.
BTW356	3 608 878 116



Mass storage

Code	Order no.
CF350	3 608 877 428

Control cabinets



Ask us – we would be happy to advise you! With the BT356 card rack, the Rexroth modular system is ideally equipped for use in control cabinets. Benefit from our experience: we can offer you advice on which control cabinet is best suited to your production environment and how control and power electronics can be integrated easily. We provide control cabinets manufactured to your requirements as well as control cabinets in the following standard dimensions:

- 1800x600x500 mm (HxWxD)* for up to 18 tightening channels or 17 tightening channels plus KE350/KE350G IL for tightening spindles in sizes 2, 3, and 4 (size 5 and mixed configurations available on request)
- 2000x600x500 mm (HxWxD)* for up to 24 tightening channels or 23 tightening channels plus KE350/KE350G IL for tightening spindles in sizes 2 and 3 (sizes 4 and 5 and mixed configurations available on request)

The standard delivery color is RAL 7032.

Other options, e.g. other colors, are available on request.

Open and flexible: Interface modules

The interface modules are the connection between the tightening system and the company's IT. Today, Rexroth offers customers all common standards of fieldbuses such as PROFIBUS and DeviceNet as well as Ethernet-based fieldbus systems.



- ▶ Perfect network connection
- ▶ Connection between the tightening system, and the company's IT
- ▶ All standard fieldbuses
- ▶ Open, modular system concept for future standards





To ensure that the tightening system optimally matches your control environment today and in the future, free slots for interface modules are included on the CS351 Compact System, the KE350, and the KE350G IL.

On delivery, the slots are closed off with covers.

CS351...-D and KE350G IL have an additional DVI interface to connect an external monitor and a corresponding USB feedback channel.

	Slot	Fieldbus/designation	Code	Order no.	Description
	A	PROFIBUS DP	IMdp	0 608 830 266	<ul style="list-style-type: none"> ▶ Data transfer via I/O level, e.g. for PLC functionality ▶ Insertion in the A slot of the KE350... or the CS351... ▶ Occupies a 400 byte address space on the fieldbus, which can be adjusted from 16I/16O points (2 bytes) to 512 I/512 O points (128 bytes), as well as 0-64 bytes ID code and 0-242 bytes data ▶ The logical assignment of the control signals is set using the BS350 operating system.
	A	DeviceNet	IMdev	0 608 830 267	<ul style="list-style-type: none"> ▶ Data transfer via I/O level, e.g. for PLC functionality ▶ Insertion in the A slot of the KE350... or the CS351... ▶ Occupies a 512 byte address space on the fieldbus, which can be adjusted from 16 I/16 O points (4 bytes) to 512 I/512 O points (128 bytes), as well as a 0-64 bytes ID code ▶ The logical assignment of the control signals is set using the BS350 operating system.
	A	PROFINET IO	IMpni	0 608 830 272	<ul style="list-style-type: none"> ▶ Complete PROFINET IO interface with IO device function (slave) ▶ Includes all analog and digital components of a powerful PROFINET IO interface connection ▶ Simple data transfer via I/O level ▶ Complies with the real-time classification (RT) of the PROFIBUS user organization ▶ Thanks to the standardized hardware and software interface to the KE350, KE350G IL and the CS351, it can be easily exchanged with other fieldbus modules of the same type.

	Slot	Fieldbus/designation	Code	Order no.	Description
	A	EtherNet/IP	IMenip	0 608 830 271	<ul style="list-style-type: none"> ▶ Complete EtherNet/IP interface with adapter function (slave), includes all analog and digital components of a powerful EtherNet/IP connection ▶ Simple data transfer via I/O level ▶ Certified module tested for interoperability with leading EtherNet/IP scanner modules ▶ Thanks to the standardized hardware and software interface to the KE350, KE350G IL and the CS351, it can be easily exchanged with other fieldbus modules of the same type.
	A	ModbusTCP	IMmtcp	0 608 830 273	<ul style="list-style-type: none"> ▶ Complete ModbusTCP interface with server function (slave) ▶ Includes all analog and digital components of a powerful ModbusTCP interface connection ▶ Simple data transfer via I/O level ▶ Thanks to the standardized hardware and software interface to the KE350, KE350G IL and the CS351, it can be easily exchanged with other fieldbus modules of the same type.
	B	24 V I/O interface	IM24V	0 608 830 259	<ul style="list-style-type: none"> ▶ Enables control over the tightening system and output of 24 V status signals via a 24 V interface ▶ Insertion in a corresponding slot on the KE350 or KE350G IL or the SE352M control unit ▶ Provides 10 inputs and 13 outputs. The outputs are short circuit-proof and protected against reverse polarity. ▶ Complies with DIN 19240.

Rexroth cables: consistent, digital data transfer

Precise control and consistently reliable measurements for checking tightening results are the outstanding features of tightening systems from Rexroth. This level of precision requires data transport that is always error-free. This is why the tightening systems from Rexroth are equipped with fully digital data communication.



- ▶ Secure and reliable data transfer thanks to digital technology
- ▶ Maximum cable length of up to 100 meters enables flexible hall design
- ▶ Connection cables for tightening spindles are suitable for robot use
- ▶ Customer-specific cable lengths available



- ▶ Connection cables for joining tightening spindles with compact or modular systems
- ▶ Connection cables for joining hand-held nutrunners with compact or modular systems
- ▶ Extension cables for extending connection cables of tightening spindles with compact and modular systems
- ▶ Network coupler cables for connecting multiple modular systems
- ▶ Measurement transducer cables for connecting individual components of a tightening spindle
- ▶ USB programming cable for connecting a PC with compact or modular systems
- ▶ Mains connection cables for joining compact systems with a power socket (included in the scope of delivery in Europe)



Cables for tightening spindles

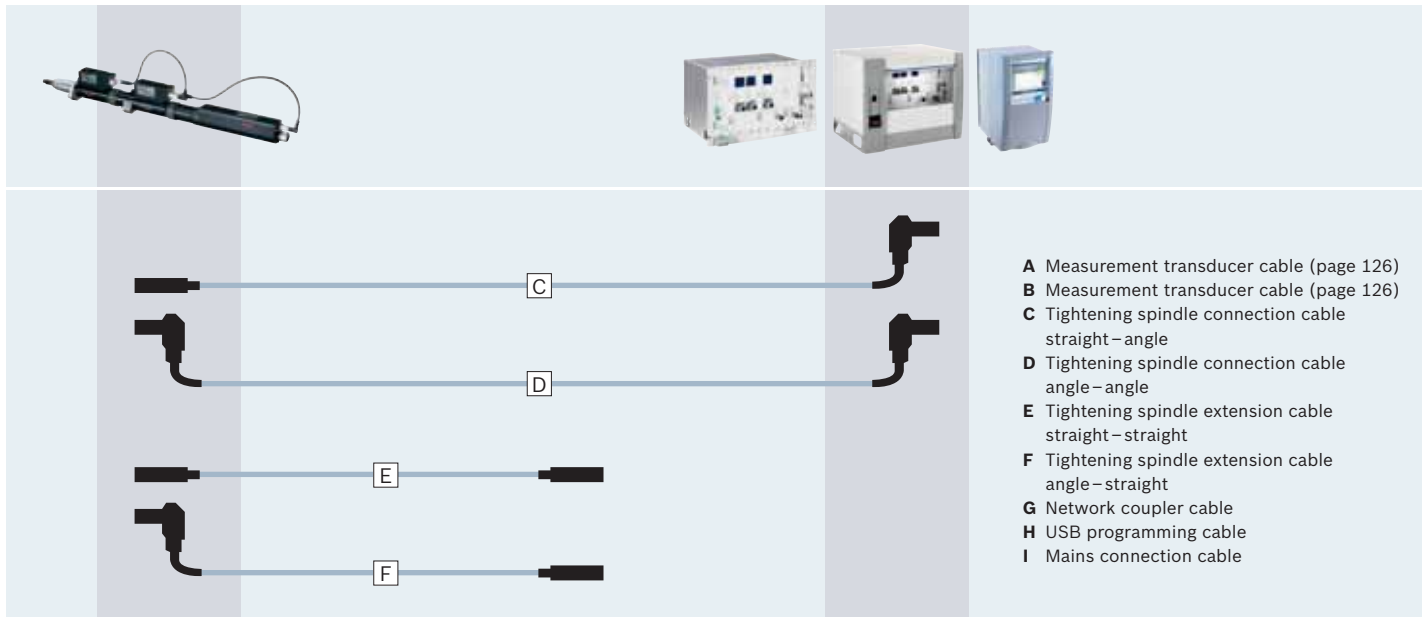
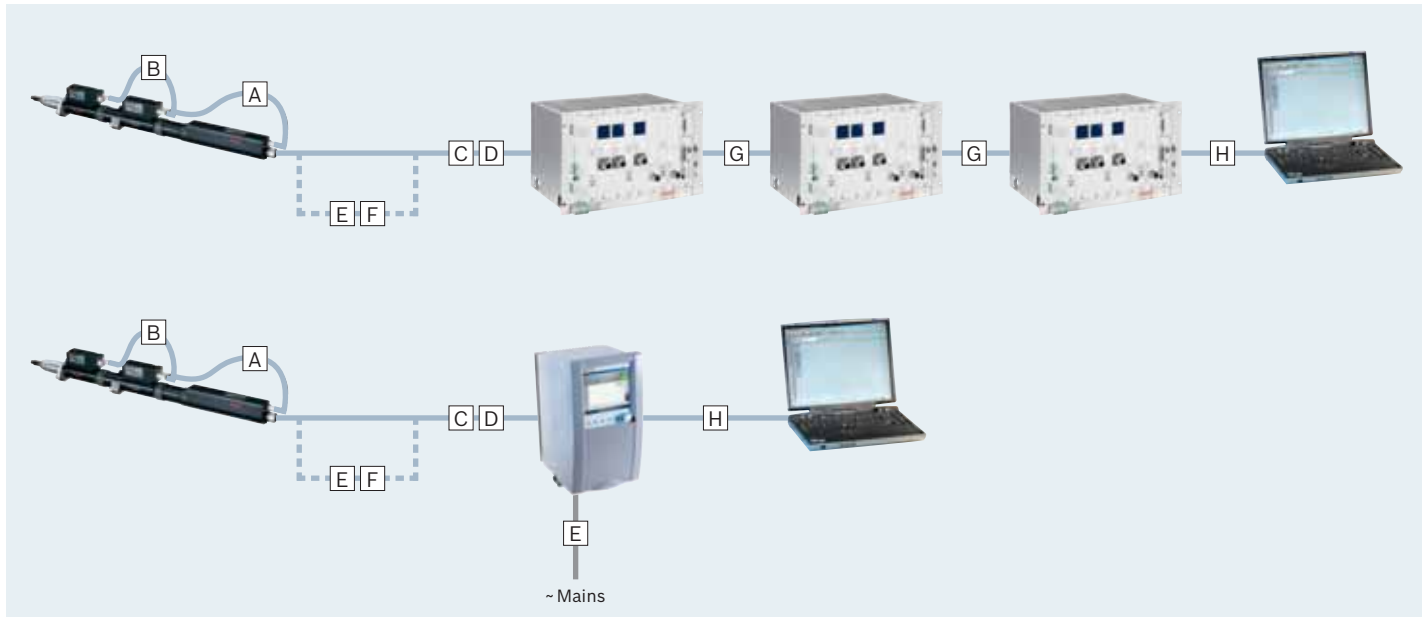

Tightening spindle connection cable

The tightening spindle is connected to the CS351S... Compact System or the LTS350D servo amplifier via a connection cable. Up to 5 extension cables may be connected to the connection cable one after the other

in any order. For applications where the tightening spindle is in constant motion, we recommend constructing the connection from several individual parts. The minimum bending radius for the listed connection cables is 132 mm. Max. length of the connection cable:

- When connecting to a system box or card rack: 100 m
- When connecting to a Compact System: 50 m

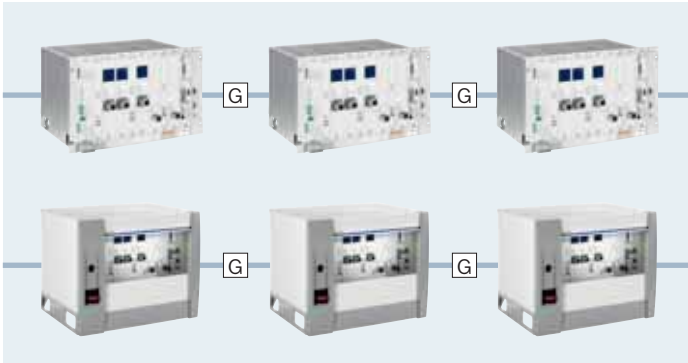

Connecting card racks and system boxes

The network coupler cables connect individual BT356 card racks and SB356 system boxes. A combination of card racks and system boxes is also possible. The length of the network coupler cable between the individual card racks / system boxes can be as much as 50 m. The total length of all network coupler cables may not exceed 150 m.

Note

To ensure function and system reliability at all times, only use the cables listed here. The connection cables for tightening spindles are suitable for robot use.

	Code	Order no.	Length m
C	SL003	0 608 830 176	3
	SL005	0 608 830 177	5
	SL007	0 608 830 190	7
	SL010	0 608 830 178	10
	SL015	0 608 830 179	15
	SL020	0 608 830 180	20
	SLF*	3 608 872 160 / ...	>0.5
	D	SLW003	0 608 830 227
SLW005		0 608 830 230	5
SLW007		0 608 830 232	7
SLW010		0 608 830 242	10
SLWF*		3 608 872 170 / ...	>0.5
E	SV003	0 608 830 188	3
	SV005	0 608 830 189	5
	SV007	0 608 830 247	7
	SV010	0 608 830 181	10
	SV015	0 608 830 182	15
	SV020	0 608 830 183	20
	SVF*	3 608 872 180 / ...	>0.5
	F	SVW003	0 608 830 243
SVW005		0 608 830 244	5
SVW007		0 608 830 245	7
SVW010		0 608 830 246	10
SVWF*		3 608 872 190 / ...	>0.5

	Code	Order no.	Length m
G	NKL0.5	3 608 877 369	0.43
	NKL002	3 608 877 370	2
	NKL005	3 608 877 371	5
	NKL010	3 608 877 372	10
	NKLF*	3 608 877 373 / ...	>0.5
H	USB350	3 608 877 427	3
E	CS351USC (110 V)**	3 608 877 033	1.8

* The connection cables SLF **C**, SLWF **D** as well as extension cables SVF **E**, SVWF **F**, and the network coupler cable NKLF **G** require a length specification in addition to the part number. The letter "F" in the code stands for flexible cable lengths in 0.5 m increments. The length and order number must both be indicated on your order.

Ordering example: Connection cable **C** 17.5 m long is SLF 3608872 160/**17.5**

** Mains connection cable, USA

(The mains connection cable is included in the standard scope of delivery for Europe.)

Measurement transducer cables

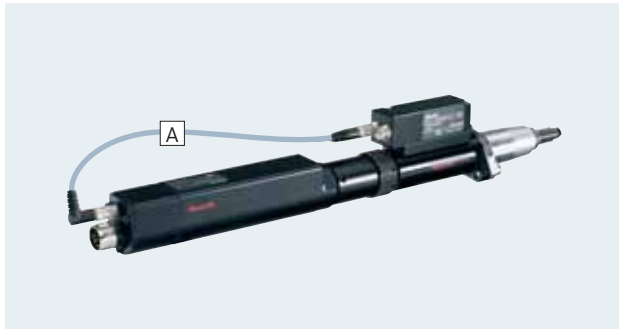

Tightening spindle with spindle bearing, offset output drive, or angle head

BG	A	Code	Order no.
2		ML036	0 608 830 171
3		ML036	0 608 830 171
4		ML046	0 608 830 222
5		ML061	0 608 830 223
5	With blocking adapter	ML061	0 608 830 236

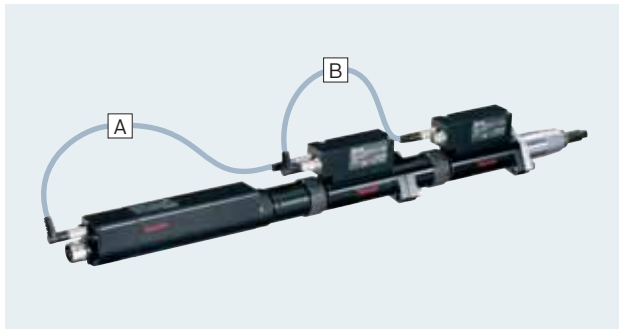

Tightening spindle with spindle bearing, offset output drive or angle head and redundant measurement transducer

BG	A	Code	Order no.	B	Code	Order no.
2		ML036	0 608 830 171		MLR033	0 608 830 174
3		ML036	0 608 830 171		MLR033	0 608 830 174
4		ML046	0 608 830 222		MLR033	0 608 830 174
5		ML061	0 608 830 223		MLR040	0 608 830 175

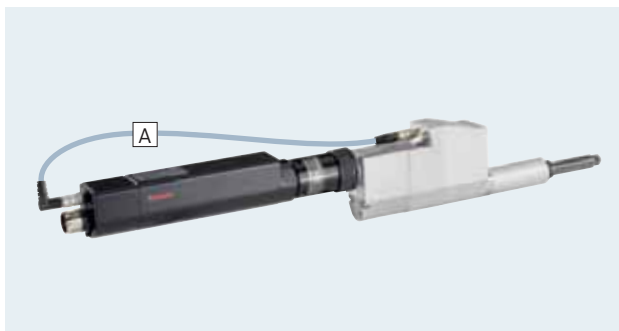

Tightening spindle with offset output drive with integrated measurement transducer

BG	VMC	A	Code	Order no.
3	3VMC0..		ML046	0 608 830 222
4	4VMC150		ML055	0 608 830 224
4	4VMC210		ML055	0 608 830 224
4	4VMC360		ML061	0 608 830 223

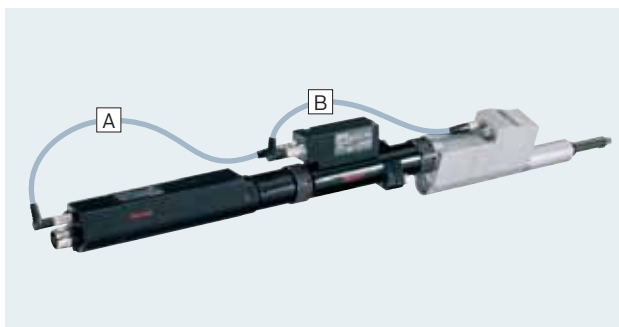

Tightening spindle with offset output drive with integrated measurement transducer and redundant measurement transducer

BG	VMC	A	Code	Order no.	B	Code	Order no.
3	3VMC0..		ML036	0 608 830 171		MLR045	0 608 830 225
4	4VMC150		ML046	0 608 830 222		MLR040	0 608 830 175
4	4VMC210		ML046	0 608 830 222		MLR040	0 608 830 175
4	4VMC360		ML046	0 608 830 222		MLR045	0 608 830 225

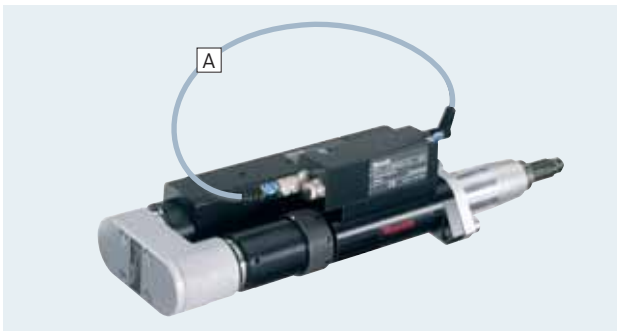

Tightening spindle with transverse gearbox

BG	A	Code	Order no.
2		ML046	0 608 830 222
3		ML046	0 608 830 222
4		ML046	0 608 830 222
5		ML061	0 608 830 223

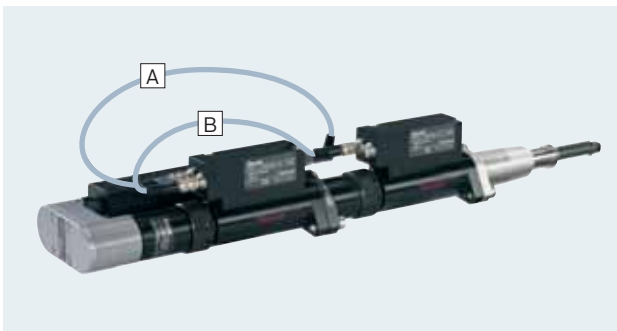

Tightening spindle with transverse gearbox and redundant measurement transducer

BG	A	Code	Order no.	B	Code	Order no.
2		ML046	0 608 830 222		MLR033	0 608 830 174
3		ML046	0 608 830 222		MLR033	0 608 830 174
4		ML046	0 608 830 222		MLR033	0 608 830 174
5		ML061	0 608 830 223		MLR040	0 608 830 175

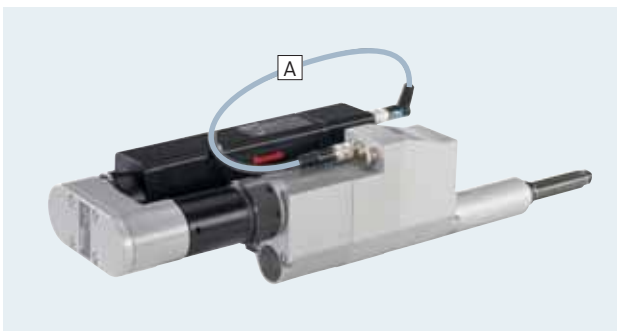

Tightening spindle with offset output drive with integrated measurement transducer and transverse gearbox

BG	VMC	A	Code	Order no.
3	3VMC0..		ML036	0 608 830 171
4	4VMC150		ML036	0 608 830 171
4	4VMC210		ML036	0 608 830 171
4	4VMC360		ML036	0 608 830 171

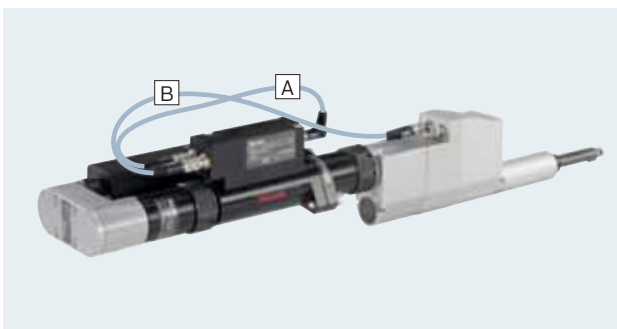

Tightening spindle with offset output drive with integrated measurement transducer and transverse gearbox and redundant measurement transducer

BG	VMC	A	Code	Order no.	B	Code	Order no.
3	3VMC0..		ML036	0 608 830 171		MLR045	0 608 830 225
4	4VMC150		ML036	0 608 830 171		MLR040	0 608 830 175
4	4VMC210		ML036	0 608 830 171		MLR040	0 608 830 175
4	4VMC360		ML036	0 608 830 171		MLR045	0 608 830 225

Cables for ErgoSpin hand-held nutrunners

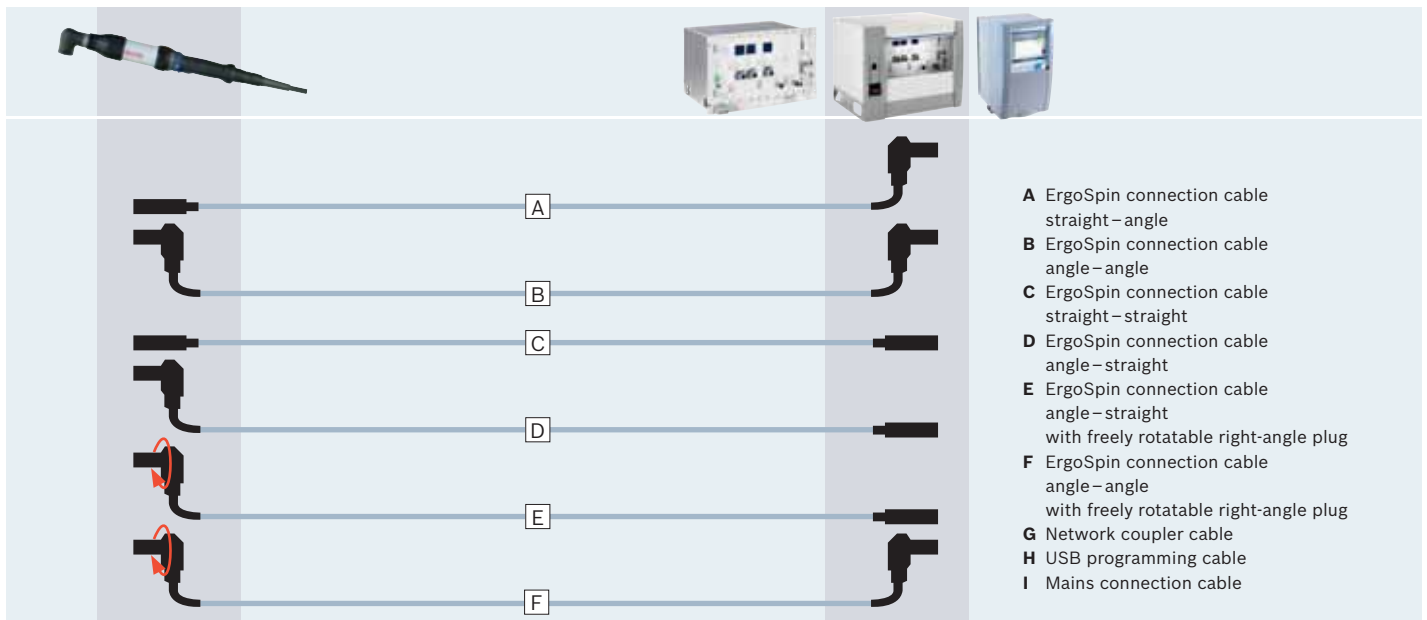

ErgoSpin connection cable

The ErgoSpin hand-held nutrunner is connected to the CS351E... Compact System or the LTE350D servo amplifier via a connection cable. Up to 5 of the connection cables listed at the side may be connected one after the other in

any order. For applications where the hand-held nutrunner is in constant motion, we recommend constructing the connection from several individual parts. The minimum bending radius for the listed connection cables is 130 mm. Max. length of the connection cable:

- When connecting to a system box or card rack: 100 m
- When connecting to a Compact System: 50 m

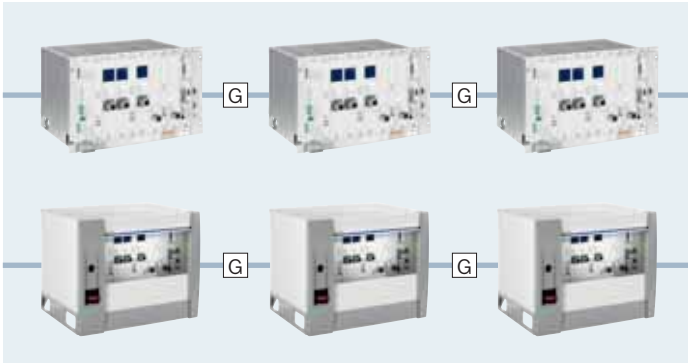

Connecting card racks and system boxes

The network coupler cables connect individual BT356 card racks and SB356 system boxes. A combination of card racks and system boxes is also possible. The length of the network coupler cable between the individual card racks / system boxes can be as much as 50 m. The total length of all network coupler cables may not exceed 150 m.

Note

To ensure function and system reliability at all times, only use the cables listed here. The ErgoSpin connection cables are suitable for robot use.

	Code	Order no.	Length m
A	AL003	0 608 750 102	3
	AL005	0 608 750 103	5
	AL007	0 608 750 104	7
	AL010	0 608 750 105	10
	AL015	0 608 750 106	15
	AL020	0 608 750 107	20
	ALF*	3 608 875 061 / ...	>0.5
	B	ALWF*	3 608 875 062
C	AV003	0 608 750 115	3
	AV005	0 608 750 116	5
	AV010	0 608 750 117	10
	AVF*	3 608 875 063 / ...	>0.5
D	AW003	0 608 750 118	3
	AW005	0 608 750 119	5
	AW010	0 608 750 120	10
	AWF*	3 608 875 064 / ...	>0.5
E	AWD003	0 608 750 121	3
	AWD005	0 608 750 122	5
	AWD010	0 608 750 123	10
	AWDF*	3 608 876 471 / ...	>0.5
F	ALWDF*	3 608 876 472 / ...	>0.5

	Code	Order no.	Length m
G	NKL0.5	3 608 877 369	0.43
	NKL002	3 608 877 370	2
	NKL005	3 608 877 371	5
	NKL010	3 608 877 372	10
	NKLF*	3 608 877 373 / ...	>0.5
H	USB350	3 608 877 427	3
E	CS351USC (110V)**	3 608 877 033	1.8

* The connection cables ALF **[A]**, ALWF **[B]**, AVF **[C]**, AWF **[D]**, AWDF **[E]**, ALWDF **[F]**, and NKLF **[G]** require a length specification in addition to the part number. The letter "F" in the code stands for flexible cable lengths in 0.5 m increments. The length and order number must both be indicated on your order.

Ordering example Connection cable **[A]** 17.5 m long is ALF 3 608 875 061/**17.5**

** Mains connection cable, USA

(The mains connection cable is included in the standard scope of delivery for Europe.)

The complete package: software and operating system

Convenient programming and analyzing: with the PC via the network or with the laptop on-site. This provides a flexible working environment and allows you to generate tightening programs as well as analyze tightening cases and conduct system tests. The user interface enables intuitive operation.



- ▶ Fast commissioning thanks to intuitive menu design
- ▶ Time-saving and mix-up-proof thanks to automatic detection of electronic components
- ▶ Simple entry of tightening process parameters
- ▶ Comprehensive selection of target and monitoring functions for adaptation to the individual tightening case
- ▶ Evaluation options using graphs and statistics for process optimization

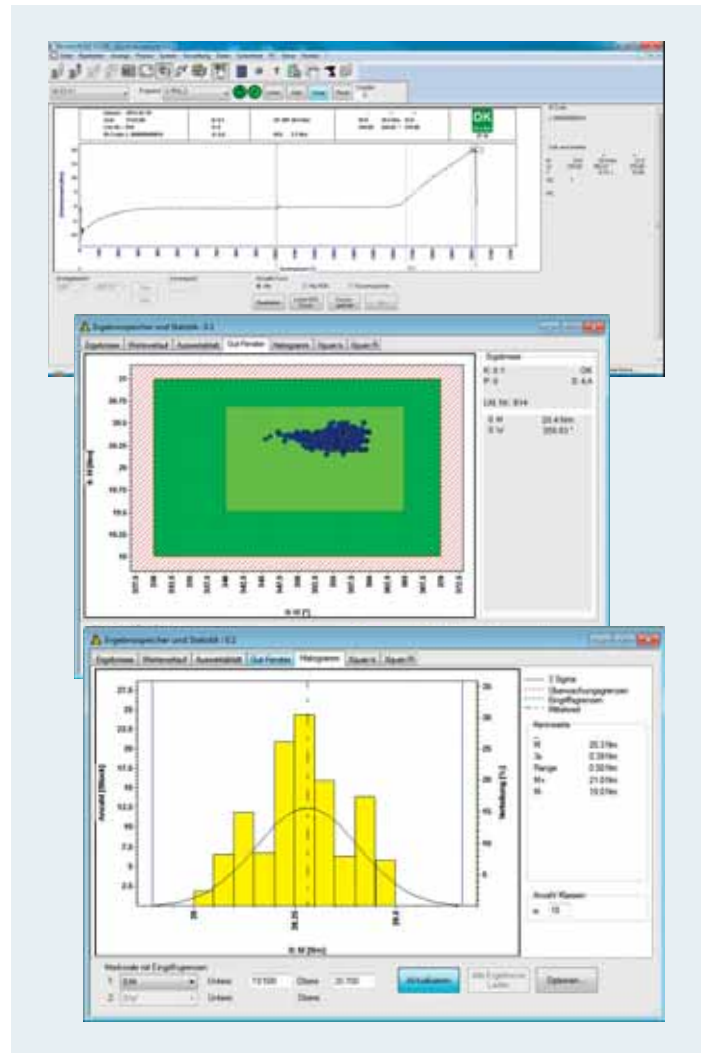
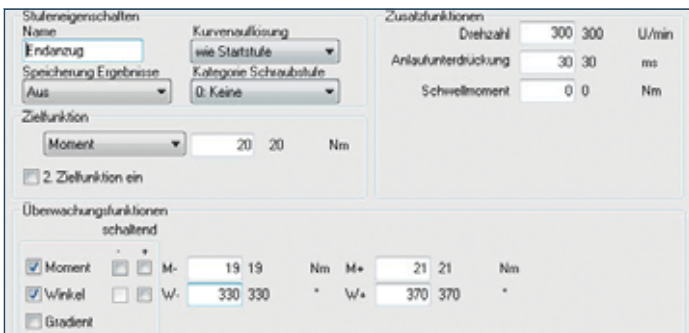

Programming

- ▶ System installation and programming of individual tightening tasks via convenient, icon-supported tools
- ▶ Configuration of tightening processes on the graphic interface
- ▶ Target and monitoring parameters are easily entered in the preset windows

Analysis

- ▶ Tightening graph for performing a quick tightening case analysis
- ▶ Good range with clear display of the state of the tightening results in the target window
- ▶ Histogram provides a quick overview of the statistical distribution of the tightening results

BS350 operating system

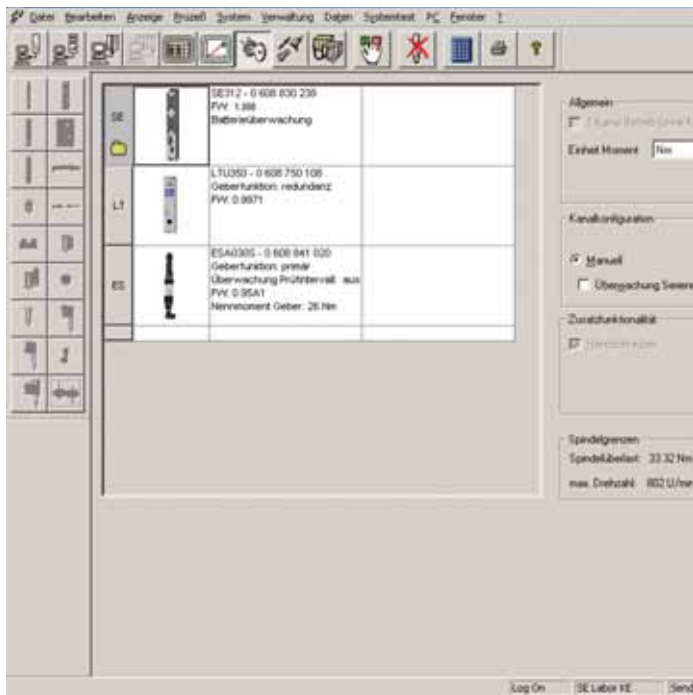

- Software for actuation, programming, and monitoring of tightening processes

Intuitive, reliable tightening processes

System installation and programming of individual tightening tasks is done via convenient, icon-supported tools. Tightening processes are configured on the graphic interface.

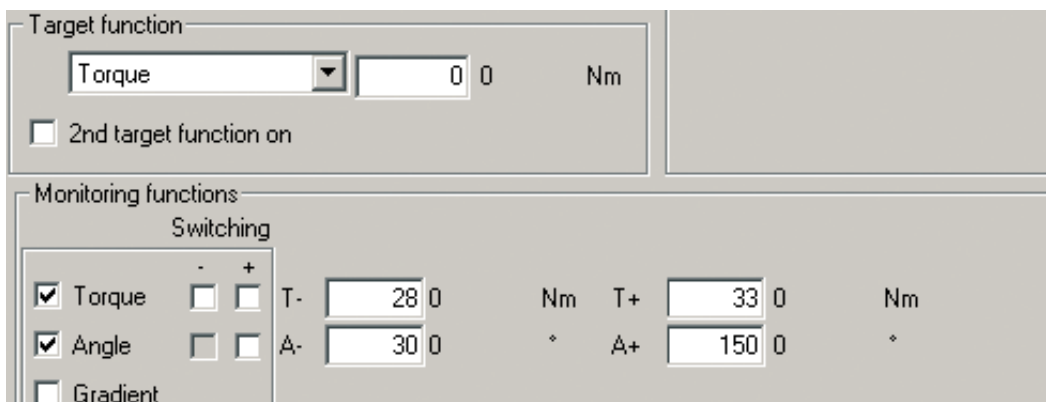

You can easily enter target and monitoring parameters in the preset windows.

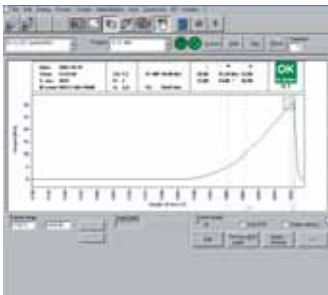

Graph
The tightening graph helps you quickly analyze tightening cases.

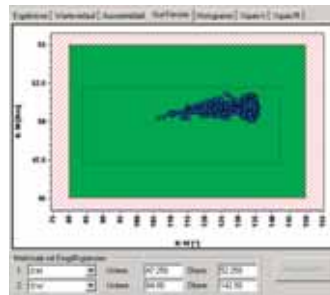

Good range window
The good range window clearly shows you the location of tightening results in the target window.

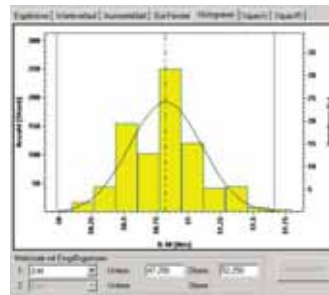

Histogram
The histogram gives you a quick overview of the statistical distribution of the tightening results.

System requirements

Windows 2000, Windows XP, Vista or Windows 7. Pentium®, or compatible microprocessors with at least 500 MHz and a minimum of 128 MB RAM. At least 100 MB of free hard drive memory. Graphics resolution: 1024 x 768. Connection to tightening system: via USB or Ethernet.

Rexroth is constantly adapting its products to meet the latest technological standards and thus retains the right to change its software and firmware. Find out about the latest software as well as software and firmware updates on the Internet at: www.boschrexroth.com/tightening



Code	Order no.	Languages
BS350 V2.300 1*	0 608 830 296	de/en/fr/it/es/pt/cs/hu/sk/pl/ru/zh
BS350 V2.300 2**	0 608 830 297	de/en/fr/it/es/pt/cs/hu/sk/pl/ru/zh
BS350 V2.300 3***	0 608 830 298	de/en/fr/it/es/pt/cs/hu/sk/pl/ru/zh

* 1x license
** 10x license
*** Plant license

de = German	es = Spanish	sk = Slovakian
fr = French	pt = Portuguese	pl = Polish
it = Italian	cs = Czech	ru = Russian
en = (US) English	hu = Hungarian	zh = Simplified Chinese

IndraWorks – the tool for all engineering tasks

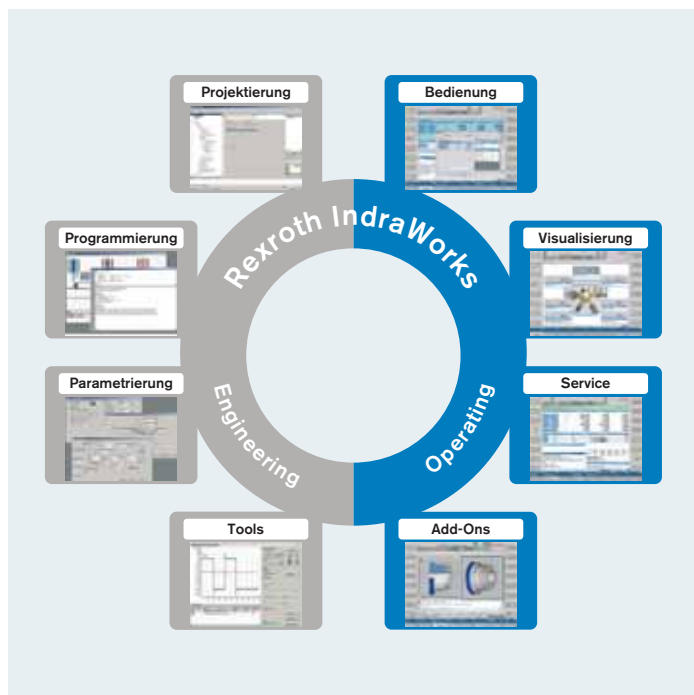

- ▶ Engineering framework for all Rexroth automation systems
- ▶ The tool for all engineering tasks

Features

- ▶ Available for all systems and solutions from Rexroth
- ▶ Integrated framework for all engineering tasks
- ▶ Consistent operating environment for project planning, programming, visualization, and diagnostics
- ▶ Central project management with intuitive system navigation
- ▶ Intelligent operation with wizard support
- ▶ Comprehensive online help
- ▶ Uniform programming according to the PLC standard IEC 61131-3
- ▶ PLCopen-conform function block and technology libraries
- ▶ Standardized interfaces for communication
- ▶ Transparent access to all system components
- ▶ Integrated FDT/DTM interface for integration of the DTM of third-party manufacturers

Rexroth IndraWorks allows you to solve all tasks in a uniform and intuitive software environment – from project planning and programming to visualization and diagnostics.

The uniform engineering framework IndraWorks is consistently available for all systems from Rexroth. You, as user, profit from fast and transparent access to all functions and system data of the automation components.

The standardized tools and interfaces help you to solve all engineering tasks centrally with a single software.

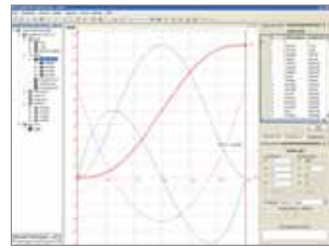
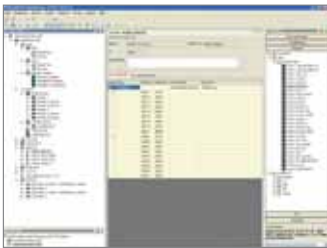

Project development

The overall system is uniformly and consistently projected for all solutions. User and multi-project management are available in all instances. The project and device explorers provide access to all system components. With its clearly organized dialog boxes, IndraWorks guides you intuitively through the configuration of your system.

Programming

The IndraLogic runtime system that is integrated in all solutions is consistently programmed in IndraWorks. The complete language scope specified in IEC 61131-3 is available. System-specific additional functions, such as motion blocks according to PLCopen or technology blocks, can be quickly and transparently implemented in your logic programs.

Tools

The tools for all engineering tasks are integrated in IndraWorks. Additional solution-specific tools are consistently available in the software framework.

Description	Type code	Order no.
IndraWorks for 350 Tightening System	SWA-IWORKS-ML*-12VRS-D0-DVD**	R911334632

You can find information on IndraWorks for the 350 Tightening System in the Internet at www.boschrexroth.com/tightening.

Customized solutions



- ▶ Handling devices with torque support for tightening spindles and ErgoSpin hand-held nutrunners.



- ▶ Telescopic balancer for fatigue-free work with hand-held tightening spindles thanks to low displacement resistance.

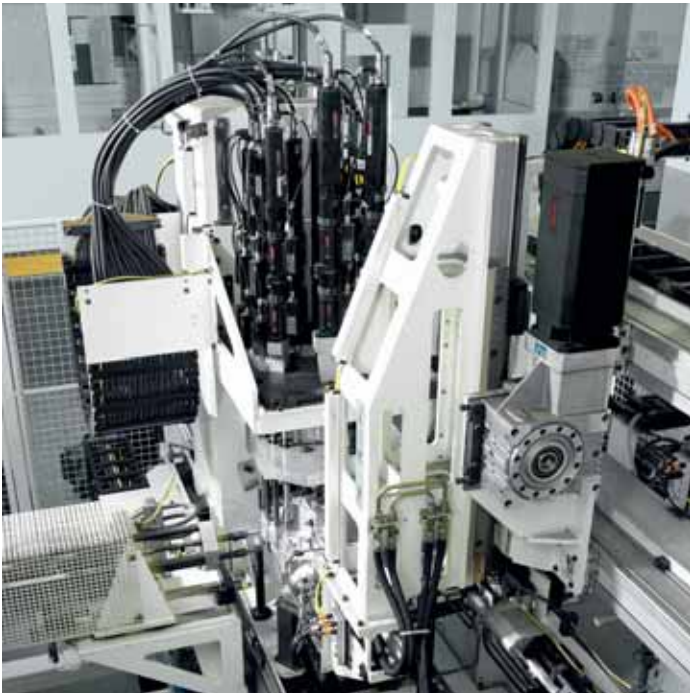

- ▶ Fully automatic tightening stations – also with nutrunner supply – that can be completely integrated into production lines.



- ▶ Worker guides and automated solutions for all aspects of the tightening position.

Rating of a tightening connection

The basic value for the rating of a tightening connection is the clamp force required to ensure the functioning of the tightening connection. Clamp force F_k must always be greater than the acting force F_A to be expected in operation ($F_k > F_A$).

The maximum number of bolts and their maximum thread value result from the design conditions, i.e. the space available for the bolts. A maximum permissible force of F_{max} can be calculated taking into consideration the stress cross-section of the bolt and the number of bolts. With currently available technology it is not possible to directly measure the clamp force (pretensioned force) during the tightening process. Therefore, it is necessary to rely on torque and angle of turn instead. Especially

in the case of torque-controlled tightening processes the clamp force is strongly influenced by the friction under the bolt head and in the threads. A tightening connection should be designed so that the minimal attainable pretensioned force F_{Mmin} guarantees the functioning of the tightening connection, but the maximum pretensioned force F_{Mmax} does not destroy the tightening connection or bolt. In order to be able to make a statement as to how the cited values will affect the mounting clamp force, the tightening factor $\alpha A = \frac{F_{Mmax}}{F_{Mmin}}$ was established in VDI 2230.

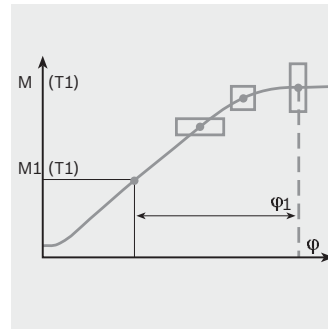
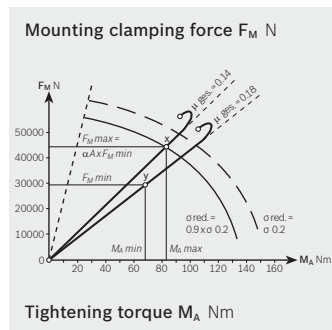
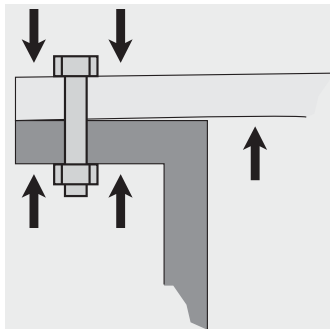

Example:
M10 DIN 912-12 g μ total = 0.14-0.18

Clamping force table according to VDI 2230

Size	Prop. class	Mounting clamp forces $F_{M Tab}$ in kN for $\mu_G =$							Tightening torques M_A in Nm for $\mu_K = \mu_G =$						
		0.08	0.10	0.12	0.14	0.16	0.20	0.24	0.08	0.10	0.12	0.14	0.16	0.20	0.24
M4	8.8	4.6	4.5	4.4	4.3	4.2	3.9	3.7	2.3	2.6	3.0	3.3	3.6	4.1	4.5
	10.9	6.8	6.7	6.5	6.3	6.1	5.7	5.4	3.3	3.9	4.6	4.8	5.3	6.0	6.6
	12.9	8.0	7.8	7.6	7.4	7.1	6.7	6.3	3.9	4.5	5.1	5.6	6.2	7.0	7.8
M5	8.8	7.6	7.4	7.2	7.0	6.8	6.4	6.0	4.4	5.2	5.9	6.5	7.1	8.1	9.0
	10.9	11.1	10.8	10.6	10.3	10.0	9.4	8.8	6.5	7.6	8.6	9.5	10.4	11.9	13.2
	12.9	13.0	12.7	12.4	12.0	11.7	11.0	10.3	7.6	8.9	10.0	11.2	12.2	14.0	15.5
M6	8.8	10.7	10.4	10.2	9.9	9.6	9.0	8.4	7.7	9.0	10.1	11.3	12.3	14.1	15.6
	10.9	15.7	15.3	14.9	14.5	14.1	13.2	12.4	11.3	13.2	14.9	16.5	18.0	20.7	22.9
	12.9	18.4	17.9	17.5	17.0	16.5	15.5	14.5	13.2	15.4	17.4	19.3	21.1	24.2	26.8
M7	8.8	15.5	15.1	14.8	14.4	14.0	13.1	12.3	12.6	14.8	16.8	18.7	20.5	23.6	26.2
	10.9	22.7	22.5	21.7	21.1	20.5	19.3	18.1	18.5	21.7	24.7	27.5	30.1	34.7	38.5
	12.9	26.6	26.0	25.4	24.7	24.0	22.6	21.2	21.6	25.4	28.9	32.2	35.2	40.6	45.1
M8	8.8	19.5	19.1	18.6	18.1	17.6	16.5	15.5	18.5	21.6	24.6	27.3	29.8	34.3	38.0
	10.9	28.7	28.0	27.3	26.6	25.8	24.3	22.7	27.2	31.8	36.1	40.1	43.8	50.3	55.8
	12.9	33.6	32.8	32.0	31.1	30.2	28.4	26.6	31.8	37.2	42.2	46.9	51.2	58.9	65.3
M10	8.8	31.0	30.3	29.6	28.8	27.9	26.3	24.7	36	43	48	54	59	68	75
	10.9	45.6	44.5	43.4	42.2	41.0	38.6	36.2	53	63	71	79	87	100	110
	12.9	53.3	52.1	50.8	49.4	48.0	45.2	42.4	62	73	83	93	101	116	129
M12	8.8	45.2	44.1	43.0	41.9	40.7	38.3	35.9	63	73	84	93	102	117	130
	10.9	66.3	64.8	63.2	61.5	59.8	56.3	52.8	92	108	123	137	149	172	191
	12.9	77.6	75.9	74.0	72.0	70.0	65.8	61.8	108	126	144	160	175	201	223
M14	8.8	62.0	60.6	59.1	57.5	55.9	52.6	49.3	100	117	133	148	162	187	207
	10.9	91.0	88.9	86.7	84.4	82.1	77.2	72.5	146	172	195	218	238	274	304
	12.9	106.5	104.1	101.5	98.8	96.0	90.4	84.8	171	201	229	255	279	321	356
M16	8.8	84.7	82.9	80.9	78.8	76.6	72.2	67.8	153	180	206	230	252	291	325
	10.9	124.4	121.7	118.8	115.7	112.6	106.1	99.6	224	264	302	338	370	428	477
	12.9	145.5	142.4	139.0	135.4	131.7	124.1	116.6	262	309	354	395	433	501	558
M18	8.8	107	104	102	99	96	91	85	220	259	295	329	360	415	462
	10.9	152	149	145	141	137	129	121	314	369	421	469	513	592	657
	12.9	178	174	170	165	160	151	142	367	432	492	549	601	692	769
M20	8.8	136	134	130	127	123	116	109	308	363	415	464	509	588	655
	10.9	194	190	186	181	176	166	156	438	517	592	661	725	838	933
	12.9	227	223	217	212	206	194	182	513	605	692	773	848	980	1092
M22	8.8	170	166	162	158	154	145	137	417	495	567	634	697	808	901
	10.9	242	237	231	225	219	207	194	595	704	807	904	993	1151	1284
	12.9	283	277	271	264	257	242	228	696	824	945	1057	1162	1347	1502
M24	8.8	196	192	188	183	178	168	157	529	625	714	798	875	1011	1126
	10.9	280	274	267	260	253	239	224	754	890	1017	1136	1246	1440	1604
	12.9	327	320	313	305	296	279	262	882	1041	1190	1329	1458	1685	1877
M27	8.8	257	252	246	240	234	220	207	772	915	1050	1176	1292	1498	1672
	10.9	367	359	351	342	333	314	295	1100	1304	1496	1674	1840	2134	2381
	12.9	429	420	410	400	389	367	345	1287	1526	1750	1959	2153	2497	2787

Guide values for clamp forces (FM) and tightening torques (MA) for headless bolts with metric coarse-pitch threads according to DIN ISO 262 and head dimensions

for hexagon bolts according to DIN EN ISO 4014 to 4018 or fillister head bolts according to DIN EN ISO 4762, and "central" hole according to DIN EN 20 273.

Glossary

Output drive	Spindle components that include the tightening tool (e.g. tightening nut).	Handling device	Manually-operated, hand-held tightening modules which the worker uses to approach the tightening position and carry out the tightening operation without exerting any force. Depending on the design, the handling device can also support the reverse torque (reaction torques).
Multiple connections	Minimum permissible distance between the tightening positions.	IEC 61131-3	Internationally recognized standard for programming languages of programmable logic controllers.
Working range	Permissible torque range of tightening spindle/ErgoSpin.	Max. output drive speed	Defined by the interaction of EC motor, planetary gearbox and output drive.
Size (BG)	Tightening spindles are available in sizes 2–5, the sizes cover different working ranges.	Measurement transducer	Spindle component that analyzes the torque, angle, and gradient and is equipped with an integrated cycle counter.
Block output drive	Combines multiple installation spindles for tight hole templates or small circle diameters.	Redundant measurement transducer	At least two independent measurement transducers that continually record the same parameters.
DVI	Digital Visual Interface – interface for the digital transfer of video data.	Center-to-center distance	See multiple connections
I/O	Input/output – I/O are discrete interfaces for sending and receiving digital signals.	Tightening case analysis	Analysis of torque and angle-of-turn measurements taken during tightening, on the basis of which conclusions about the tightening process and the quality of the tightening connection can be made.
EC Motor	Electronic Commutated motor – a brushless, and thus maintenance-free, motor.	Tightening channel	Includes all components required for a tightening job: tightening spindle or ErgoSpin hand-held nutrunner, connection cable, as well as control and power electronics.
ErgoSpin	A hand-held nutrunner designed according to the latest findings in ergonomics.	Tightening program	Controls the tightening process and is divided into various tightening steps, where tightening parameters are set.
Range of spring	Travel output which results from engaging the tightening module and tightening until the screw-in depth is reached.		
Crowfoot wrench	Special components designed for very tight and hard-to-reach tightening positions.		
Gradient	Inclination of a tangent in the torque/ angle of turn graph.		

Tightening spindle	Comprises an output drive unit, measurement transducer and a gearbox-motor combination for the drive and is used with hand-held and automatic tightening tasks.	System Stick	A USB stick included in the scope of delivery that contains, among other things, the installation program for the BS350 Operating System and the system documentation.
Tightening station	Hand-held, manually-operated, or automatic tightenings are carried out on a tightening station. It can be a part of an assembly line.	Avg. efficiency	Quotient calculated from output drive performance and drive performance. The output drive performance and drive performance depend on the speed and torque, which is why efficiency is not constant.
Tightening position	Refers to the defined location where the tightening job is performed using a tightening channel and a tightening program.	Offset output drive	Output drive component for tight center to center distances where the spline shaft and drive unit are offset.
Tightening system	A complete system with all of the tightening channels that are needed to carry out the defined tightening case. It communicates with a superior controller.	Feed output drive	Output drive component for deep-seated tightening positions (e.g. motor plugs).
IP54 protection class	Suitability of components for certain ambient conditions, e.g. for industrial systems. IP54 refers to the protection against splash water and dust.	Tool mount	Interface between the tightening spindle and tool. For example, a square is a typical tool mount for a tightening nut as a tool.
Spindle bearing	Output drive component with straight spline shaft which supports the tightening tool (e.g. tightening nut).	Angle head	Output drive components which are used from above, usually on the hand-held nutrunner, if there is limited space available (e.g. inner housing tightening).
Socket tray	Container for various tool inserts. Corresponding tightening programs are activated when the tools are removed	Feed gripper	Component used to store and supply bolts to the tightening tool.
Controllers	Controls and monitors the tightening process or exchanges data with superior controllers.		

Bosch Rexroth AG

Fornsbacher Str. 92
71540 Murrhardt, Germany
www.boschrexroth.com/tightening

You can find your local contacts at:

www.boschrexroth.com/contact